

SMS «MOLTKE»

Iron Flush-decked Corvette, 1878

MOLTKE

Гладкопалубный корвет

с железным корпусом

«МОЛЬТКЕ»

Германия, 1878

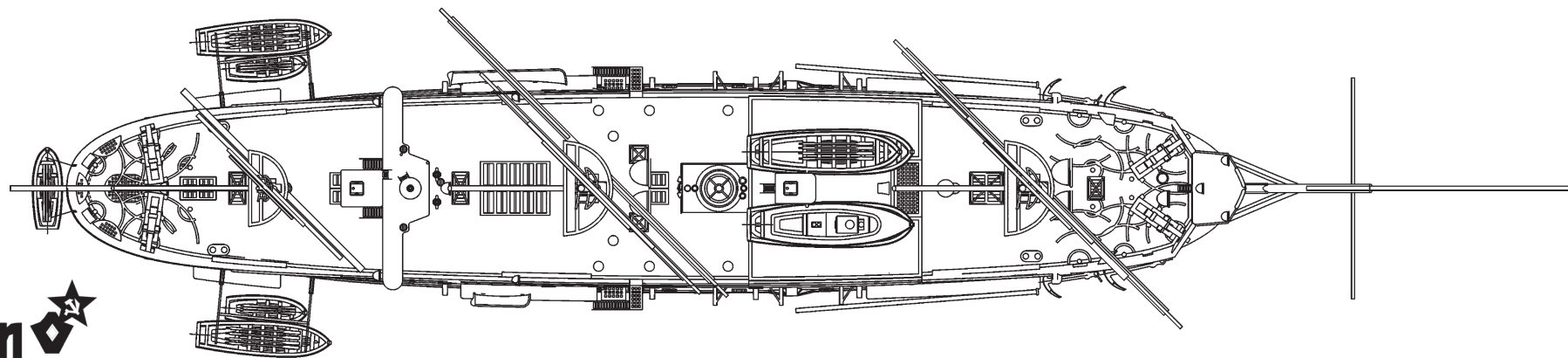
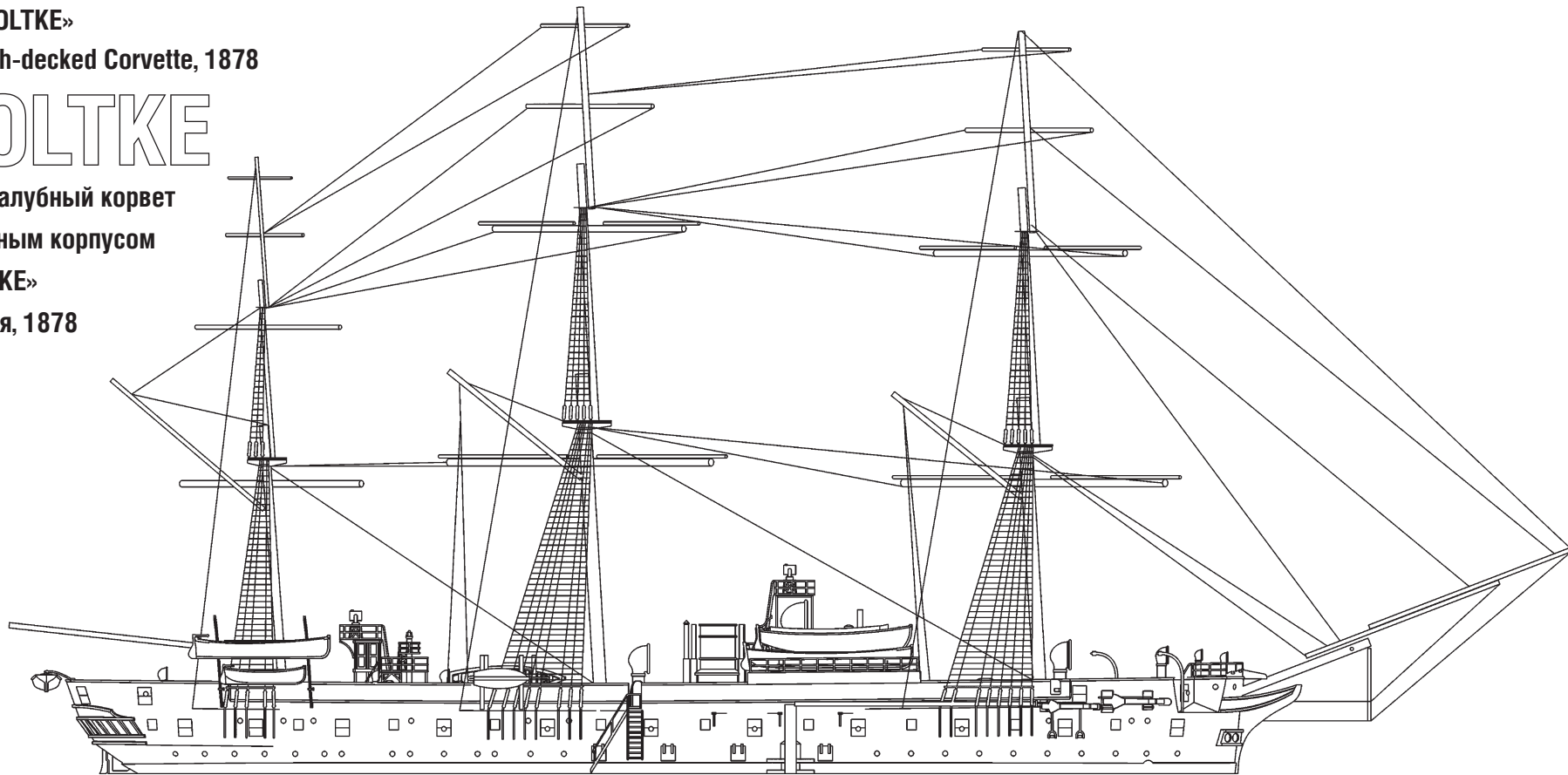

**Ком
Бриг**
Made in Russia

70072 For more info on Combrig kits see: www.combrig-models.com www.steelnavy.net www.modelwarships.com

1:700

**masts & yardarms
self made parts**

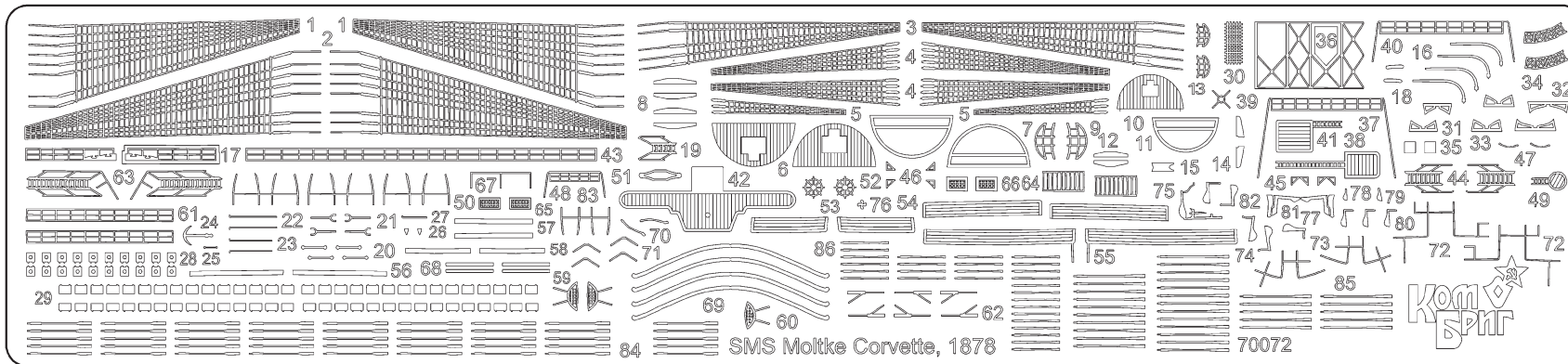
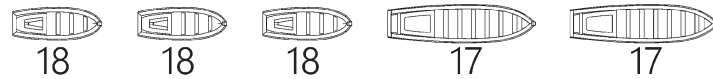
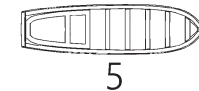
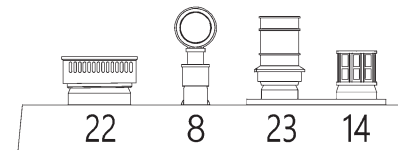
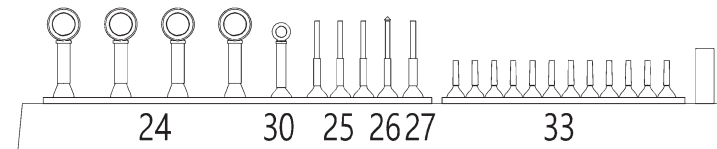
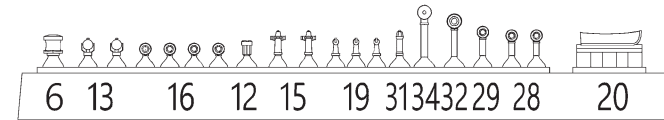
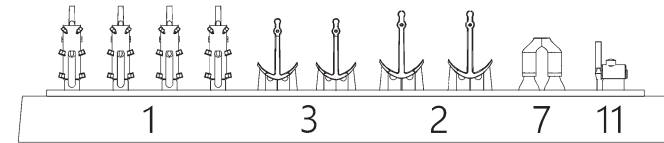
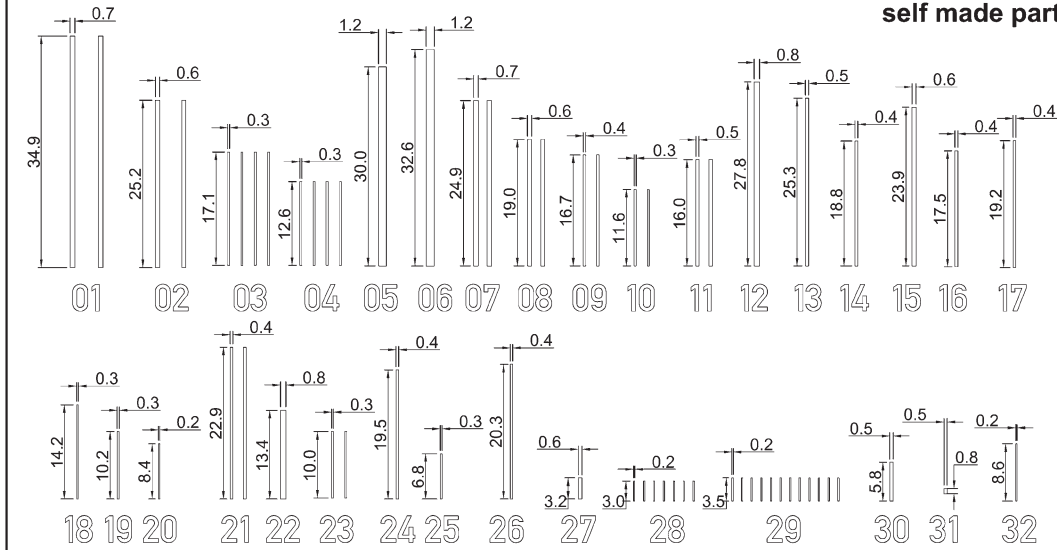

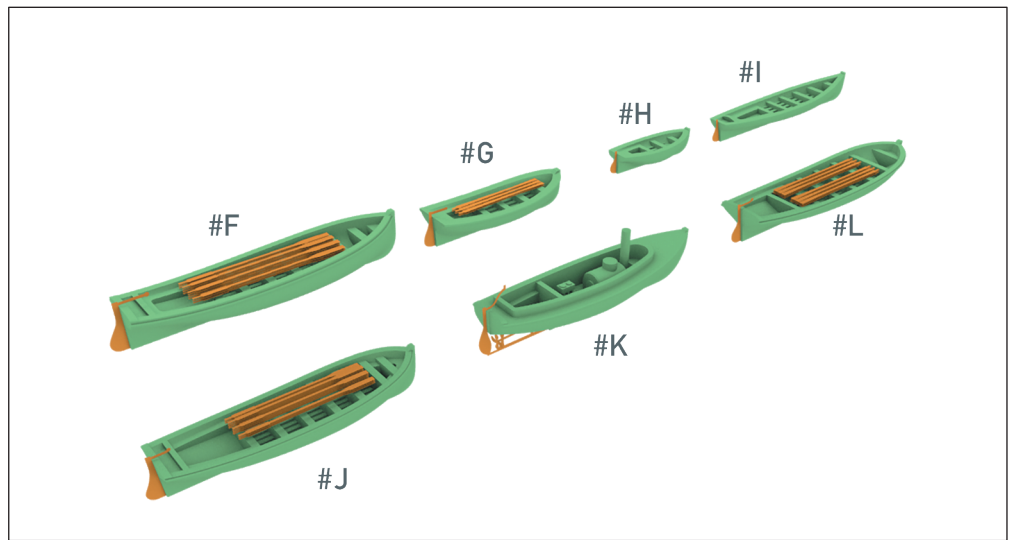
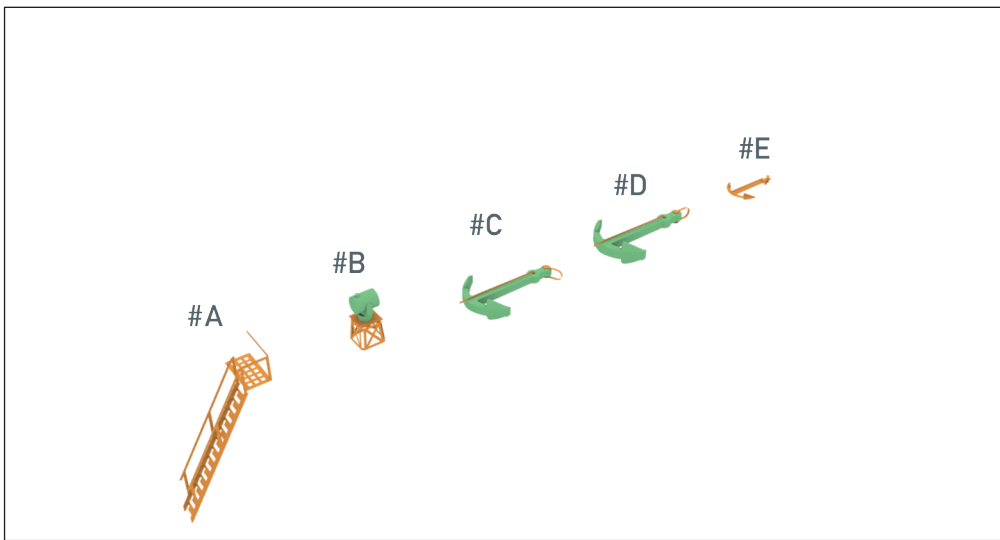
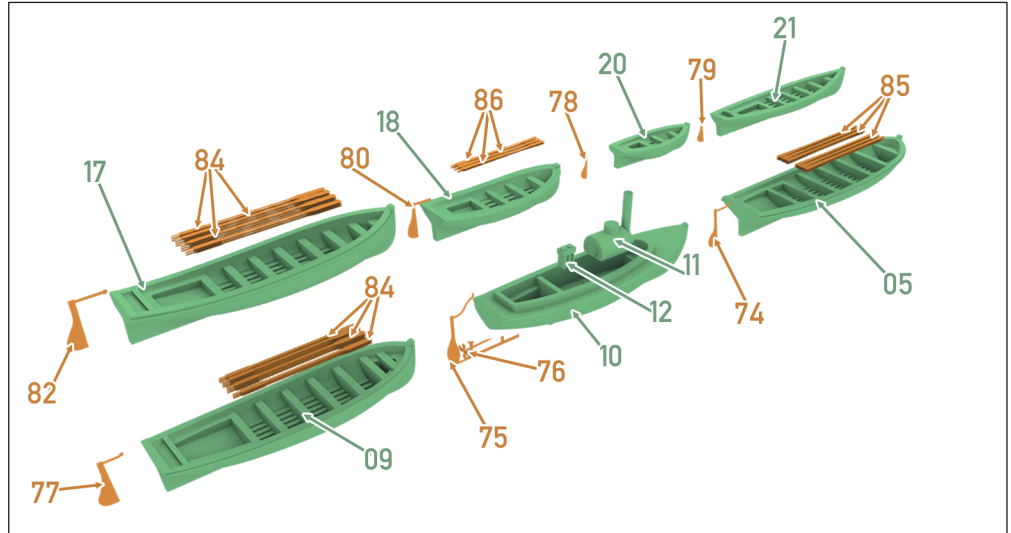
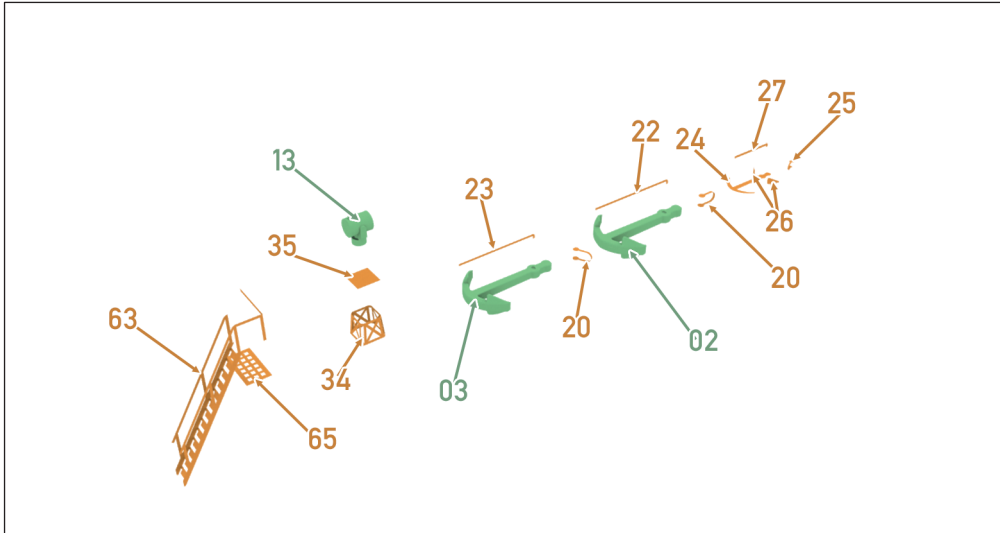

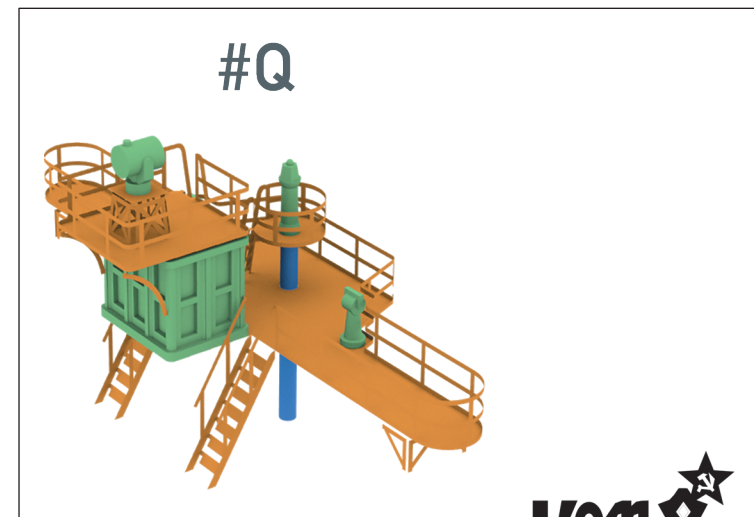
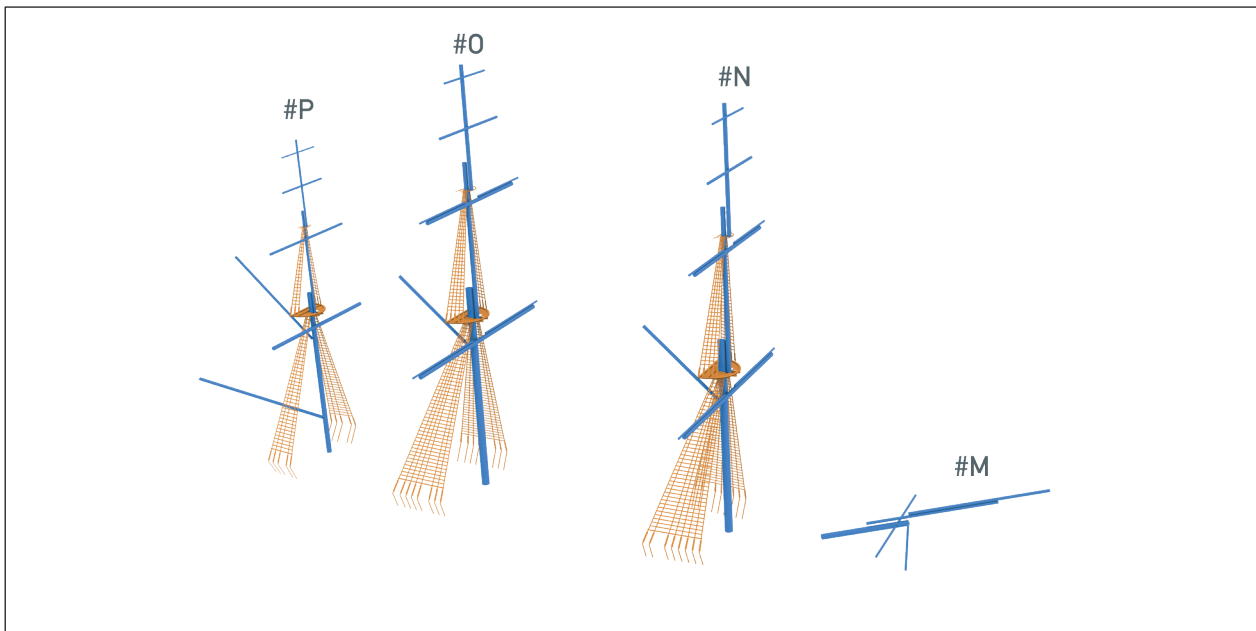
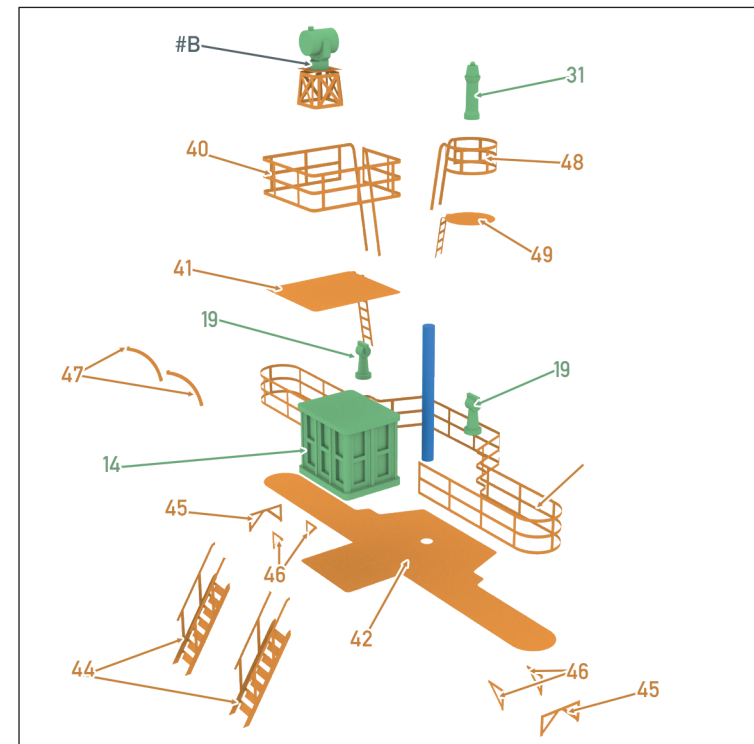
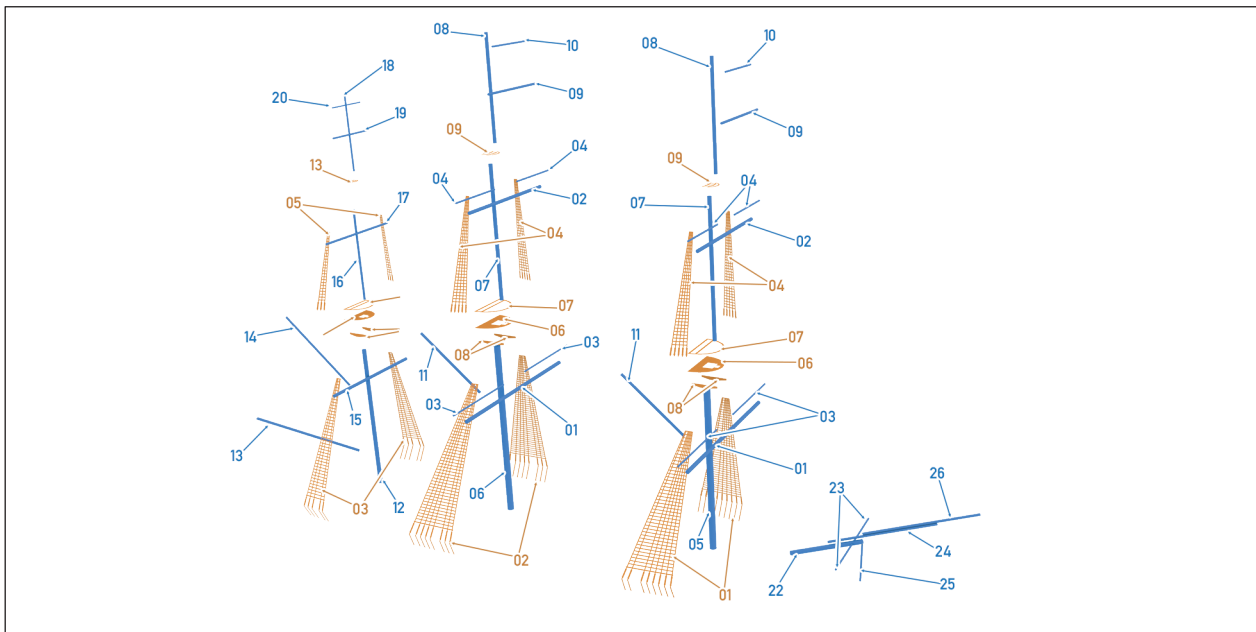

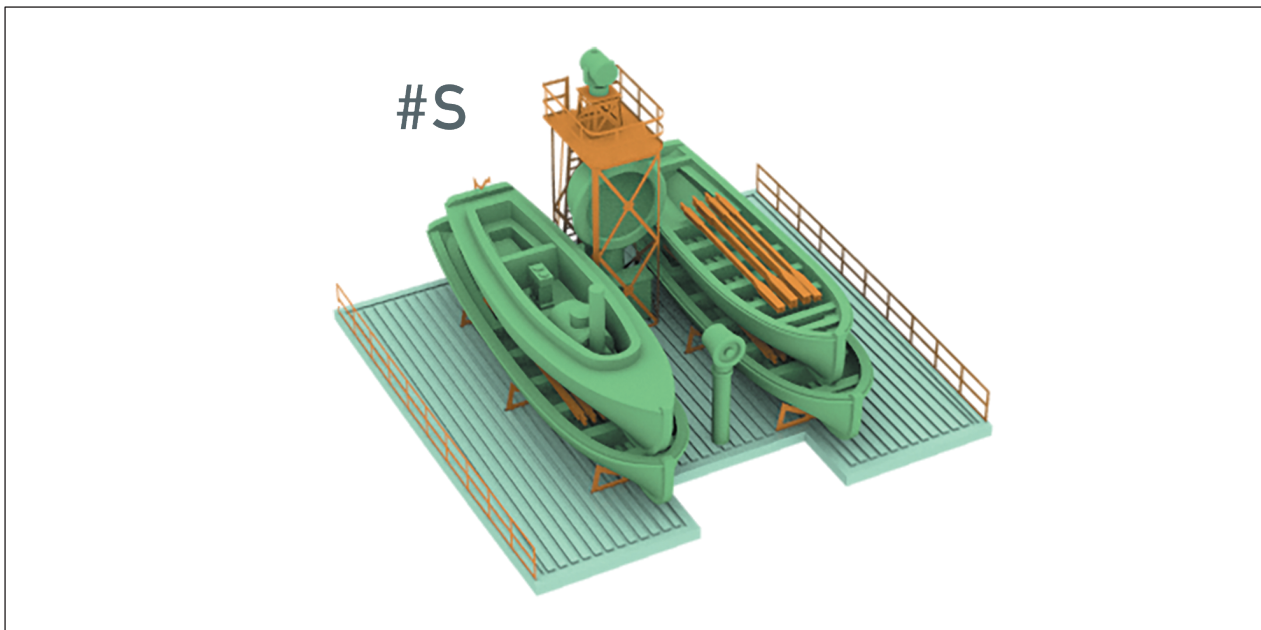
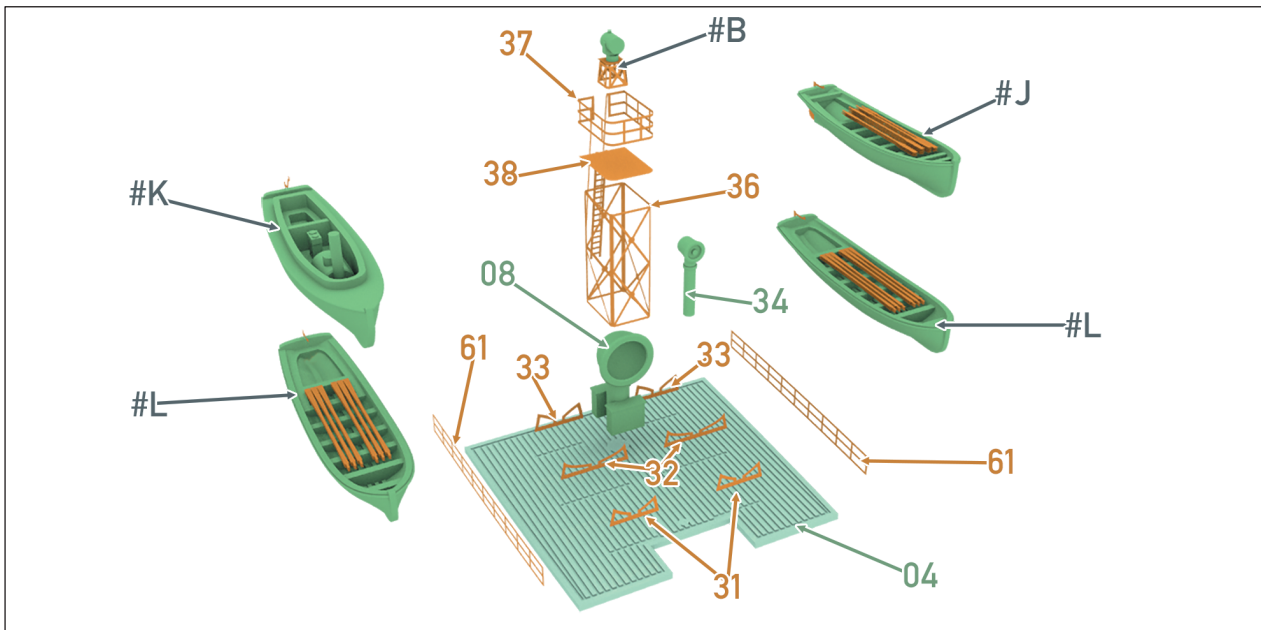
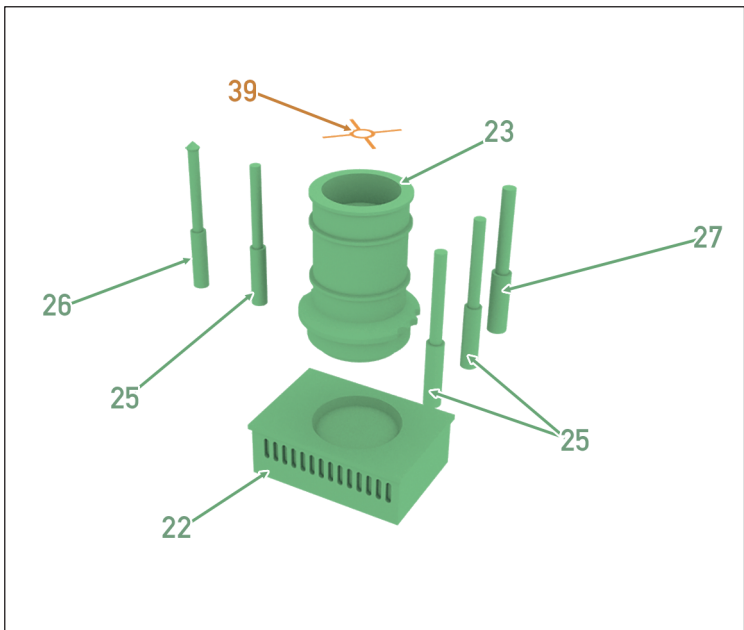

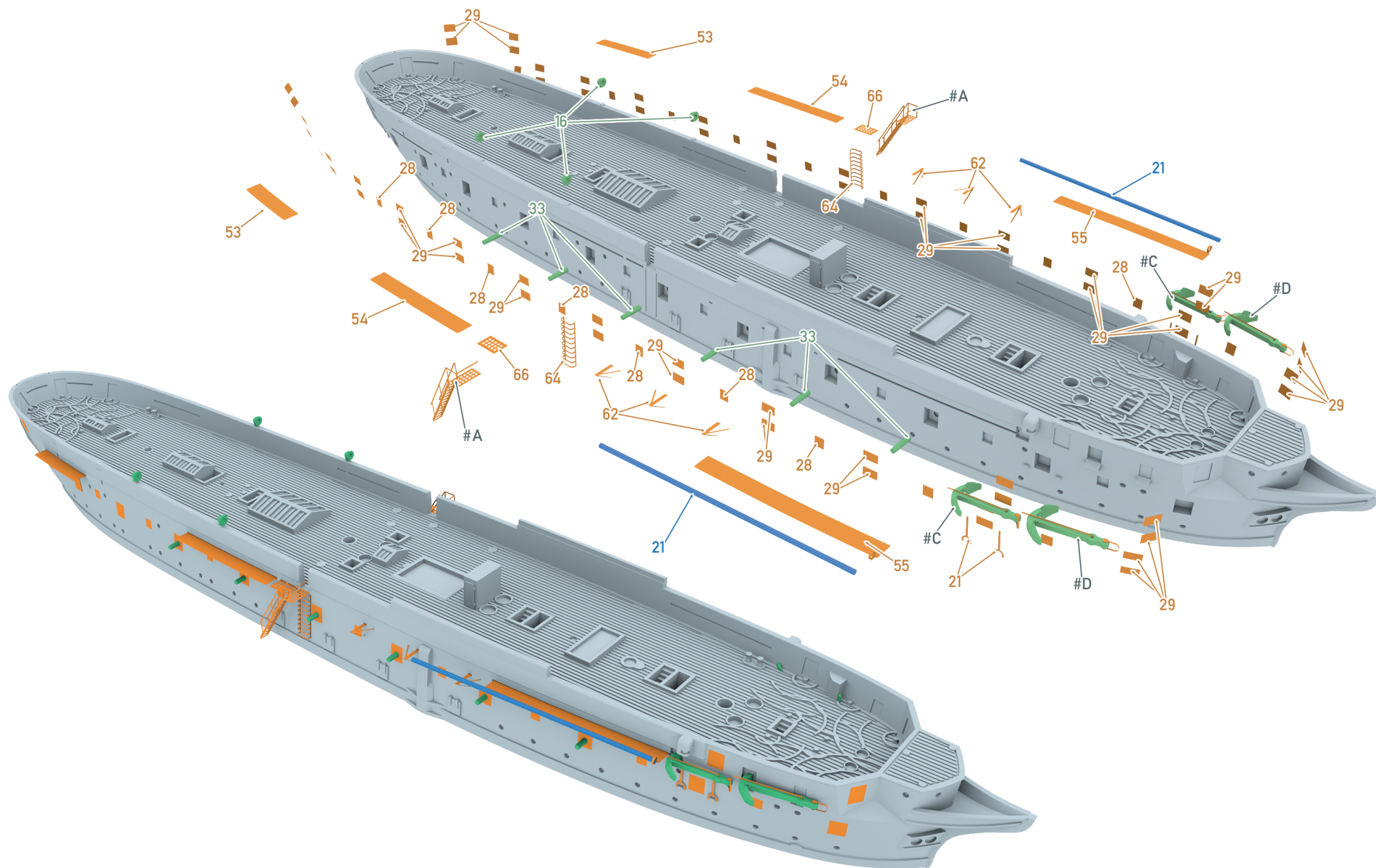

70072 For more info on Combrig kits see: www.combrig-models.com www.steelnavy.net www.modelwarships.com

1:700



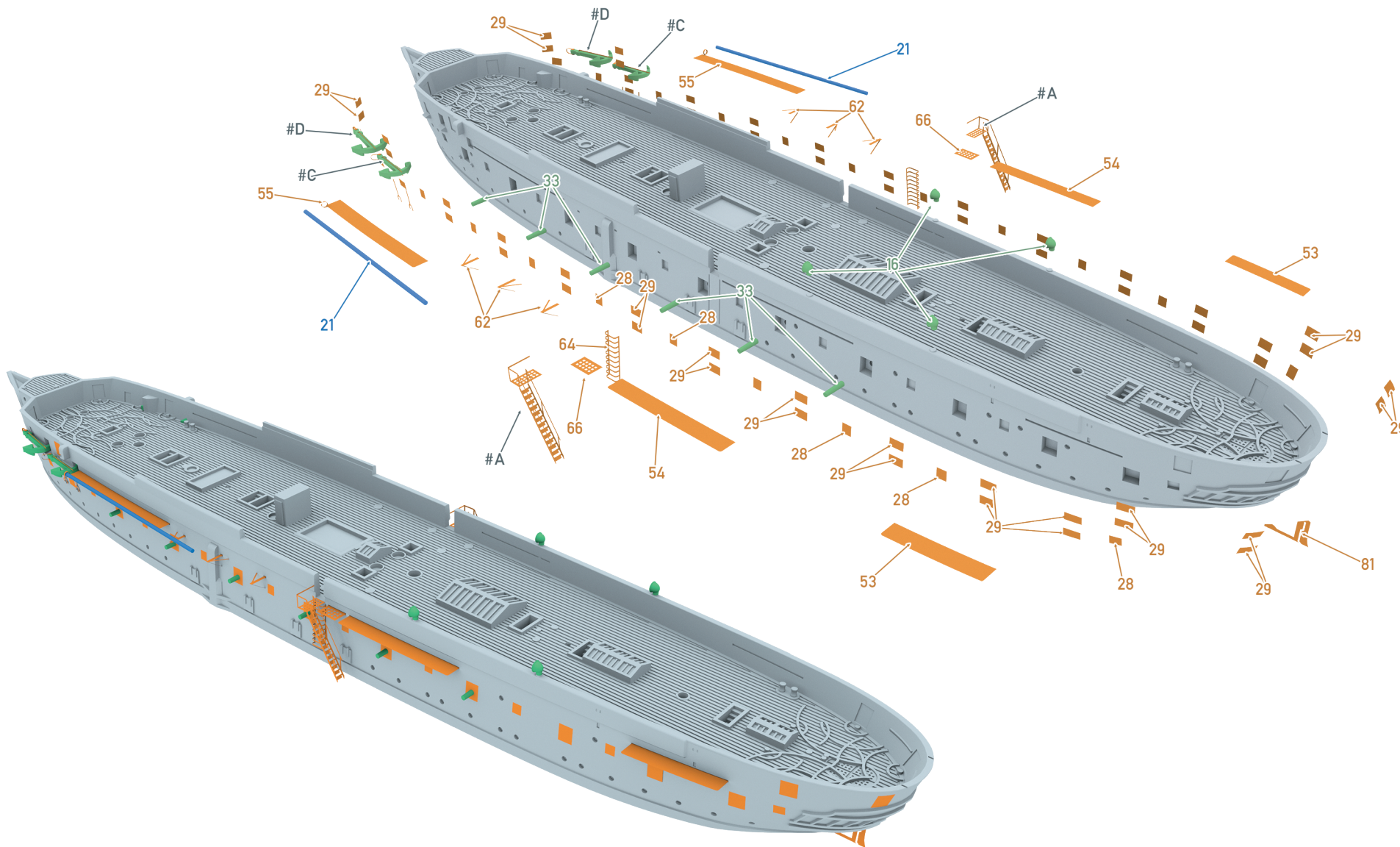

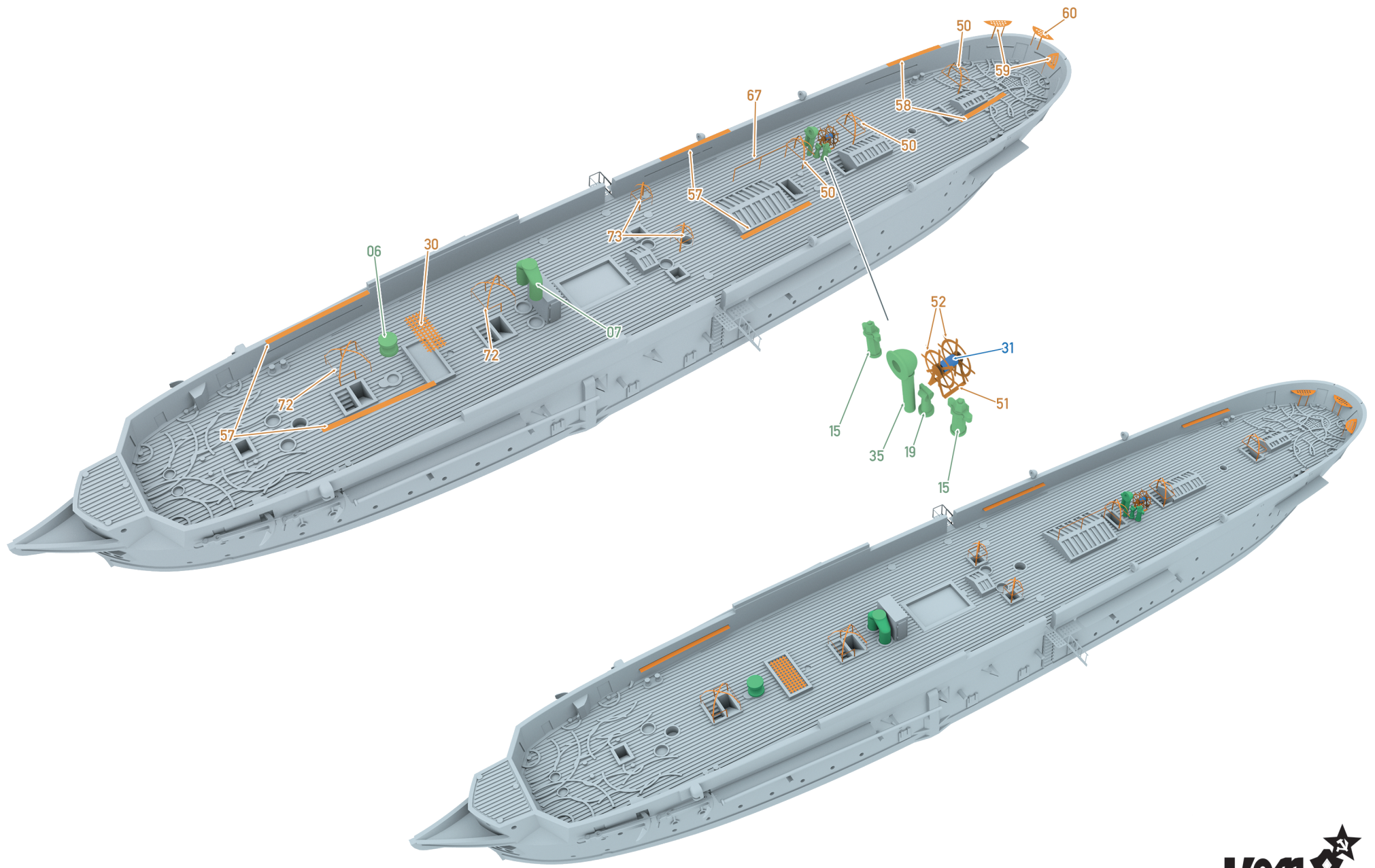

70072 For more info on Combrig kits see: www.combrig-models.com www.steelnavy.net www.modelwarships.com

1:700



