

SMS Minelaying Cruiser, 1908

ALBATROSS

Германский Минный Заградитель, 1908

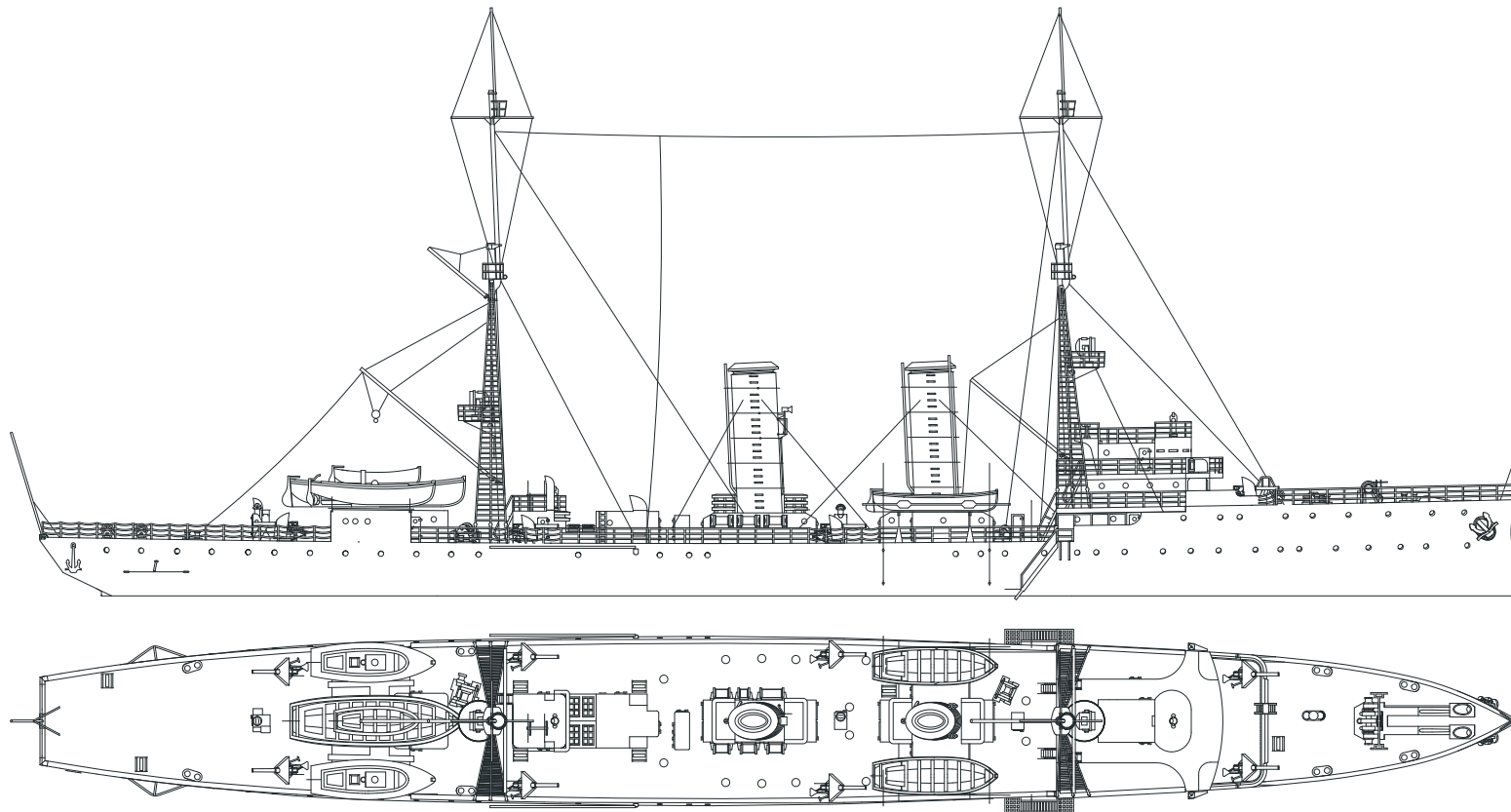

SMS Albatross — минный заградитель императорских военно-морских сил Германии. Построен в 1907-1908 годах в серии из двух заградителей - SMS Nautilus

(1906) SMS Albatross. Участвовал в Первой мировой войне, ставил мины у берегов Англии и в Балтийском море. В 1915 году в бою у острова Готланд был

поврежден русскими крейсерами, в результате выбросился на берег. В 1915 году корпус снят с камней шведами а в 1921 году и сдан на слом в Германии.



70400 For more info on Combrig kits see: www.combrig-models.com www.steelnavy.net www.modelwarships.com

1:700

masts & yardarms self made parts

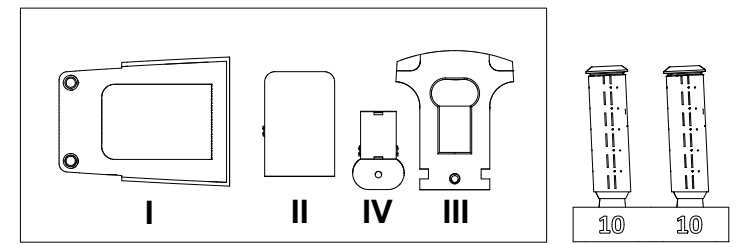
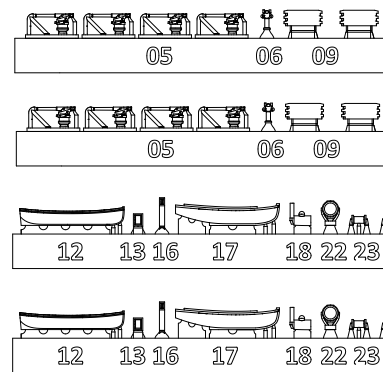
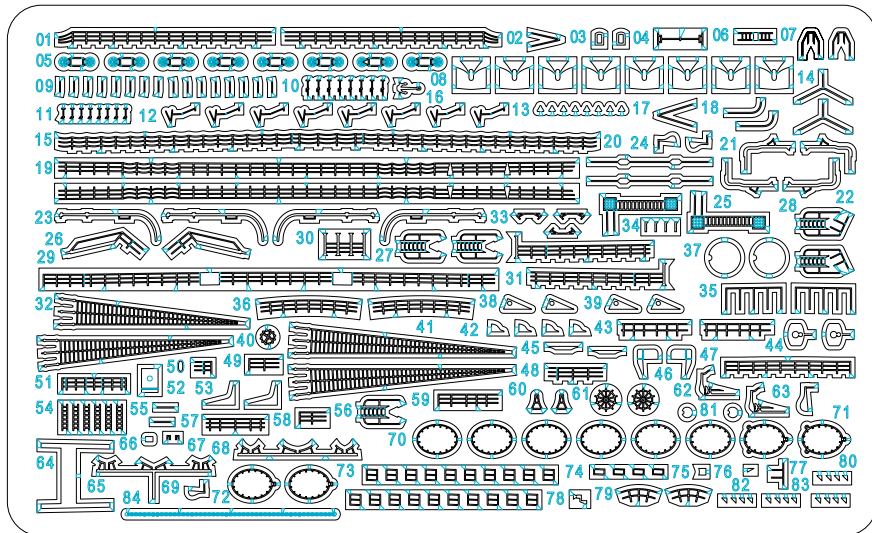
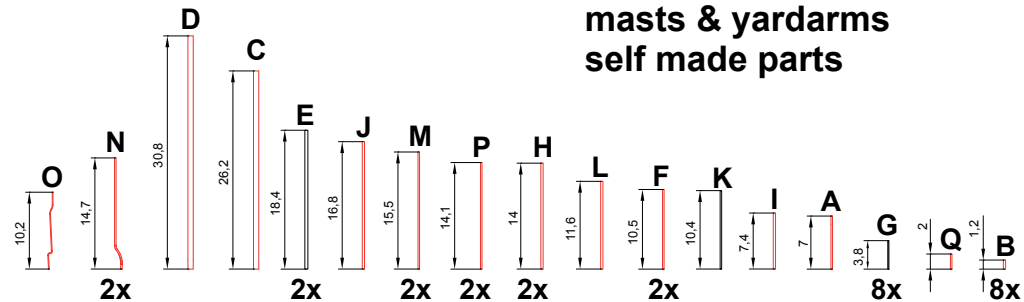

#9

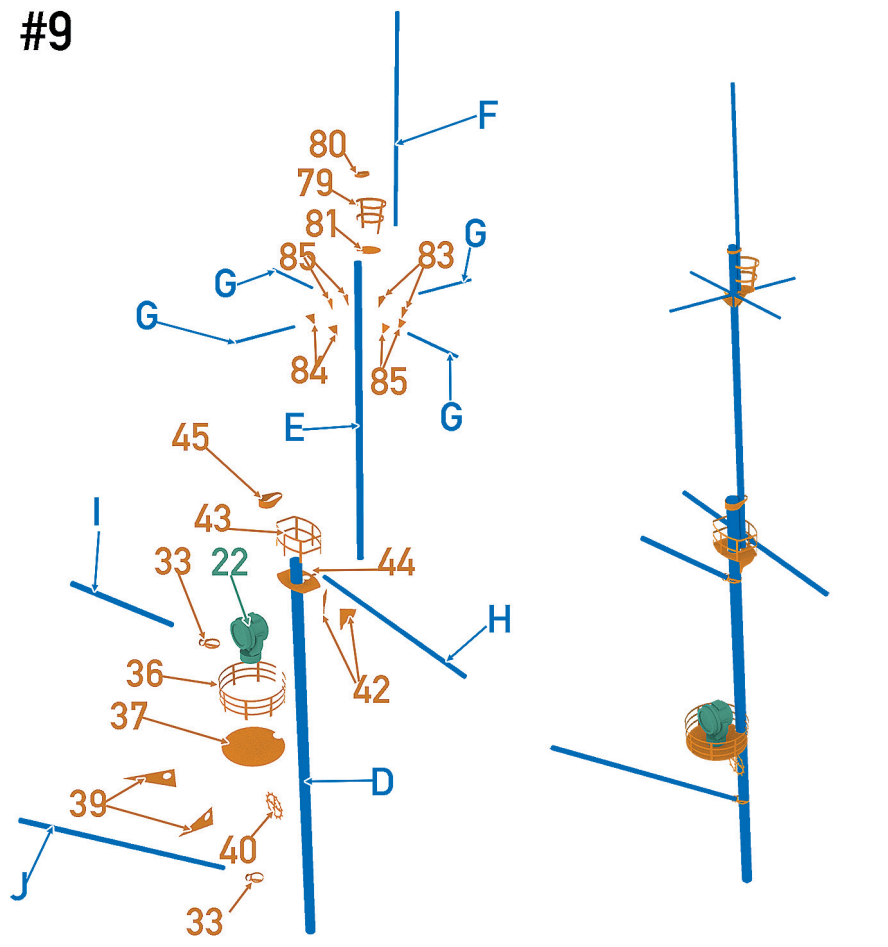

#5

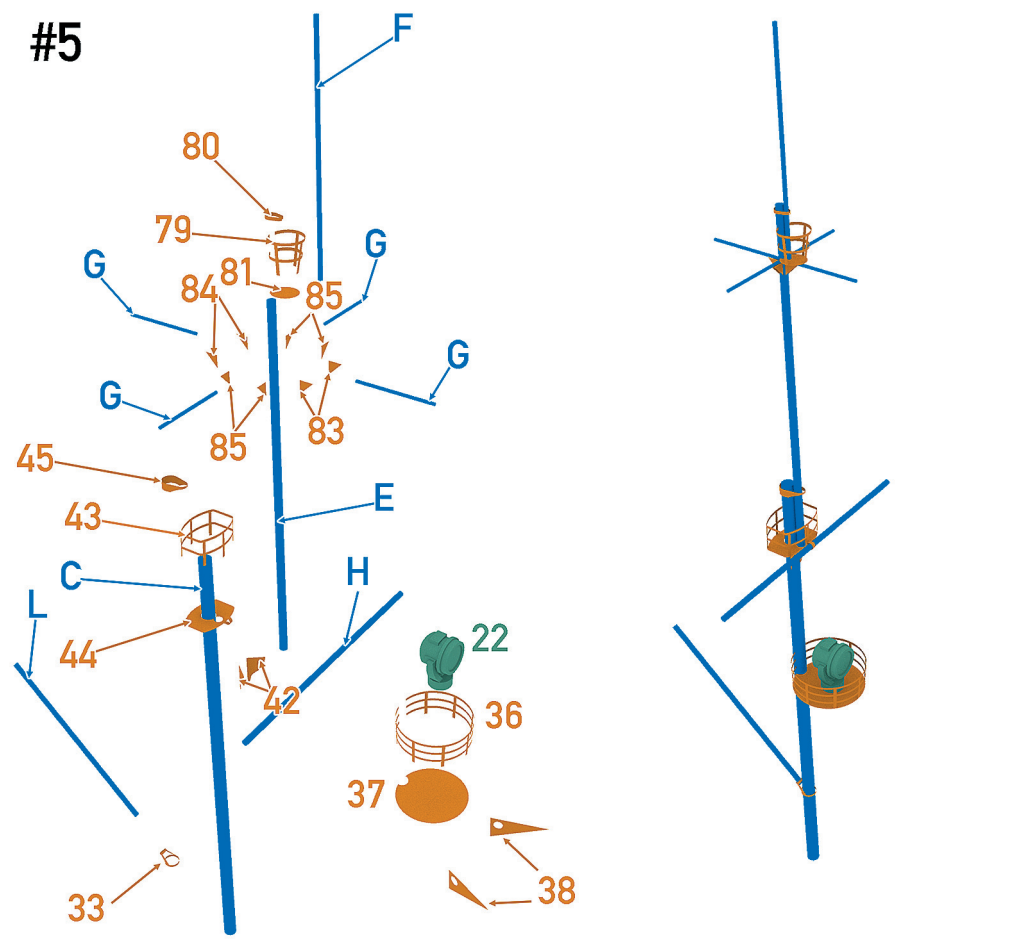

#4

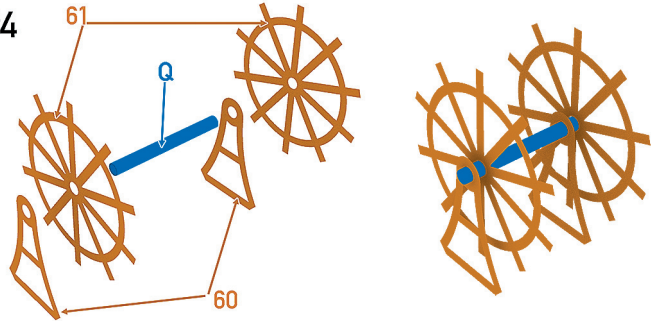

#6

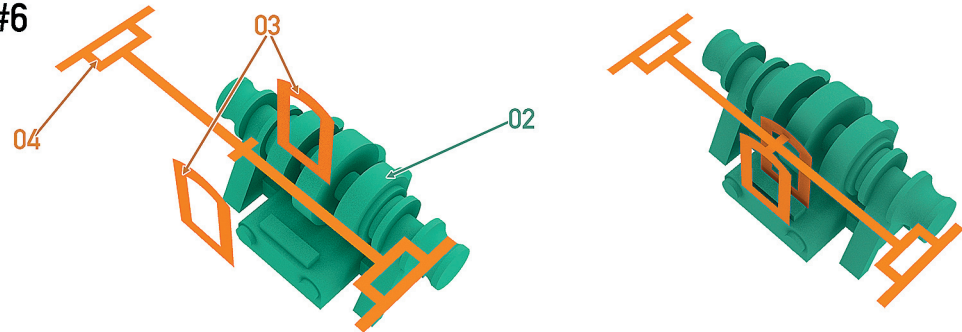

#1

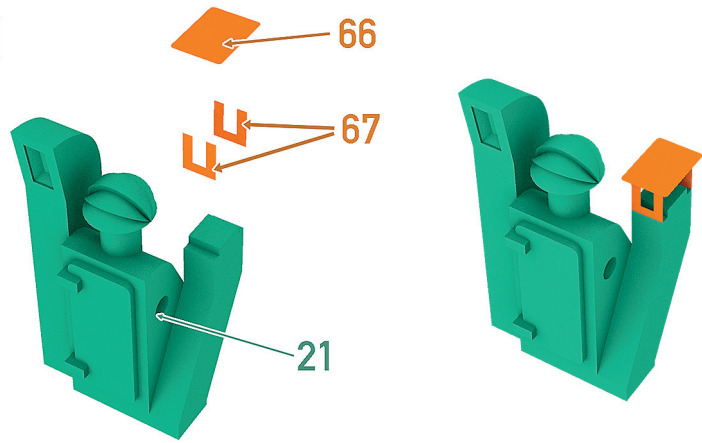

#10

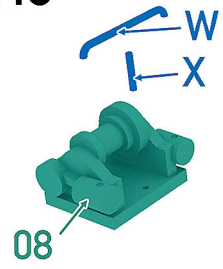

#11

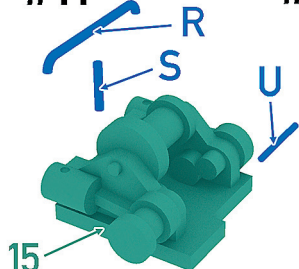

#12

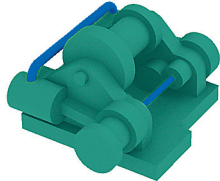
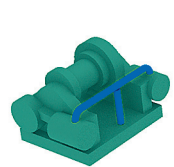

#2

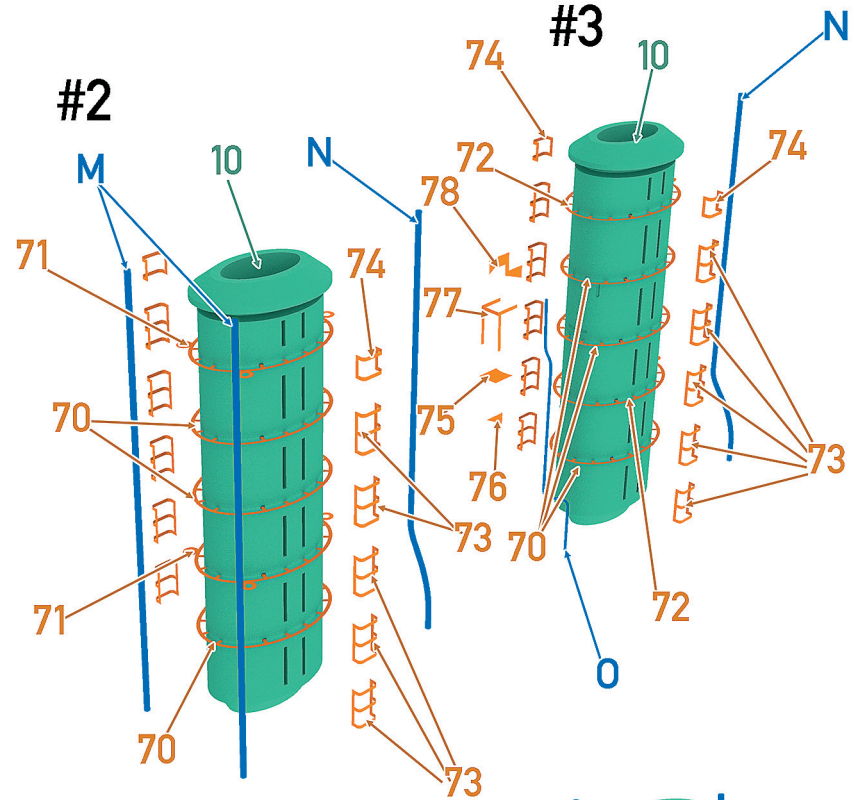

#3

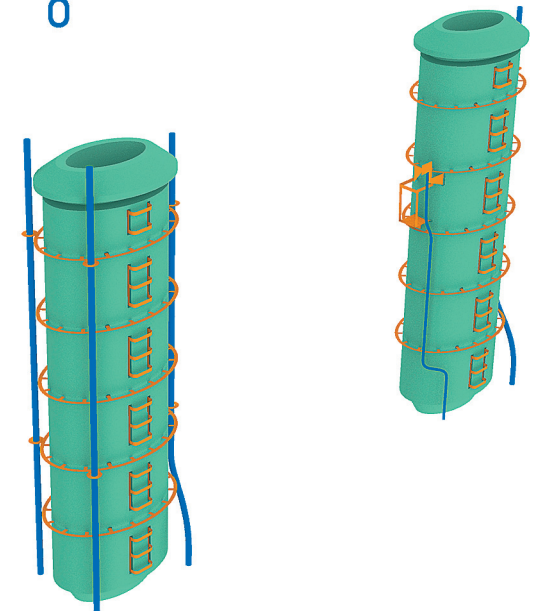

#8

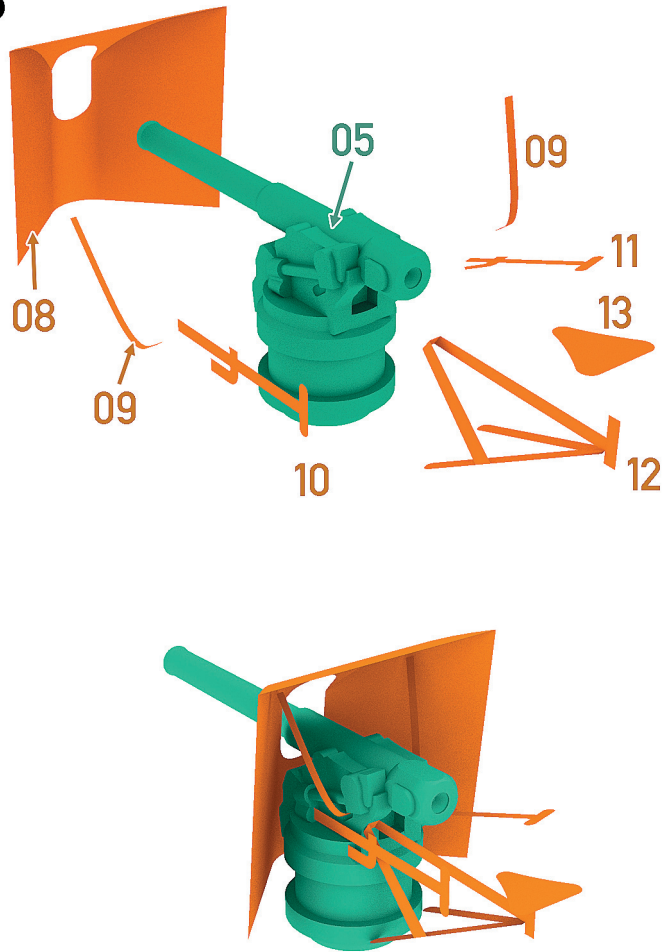

#7

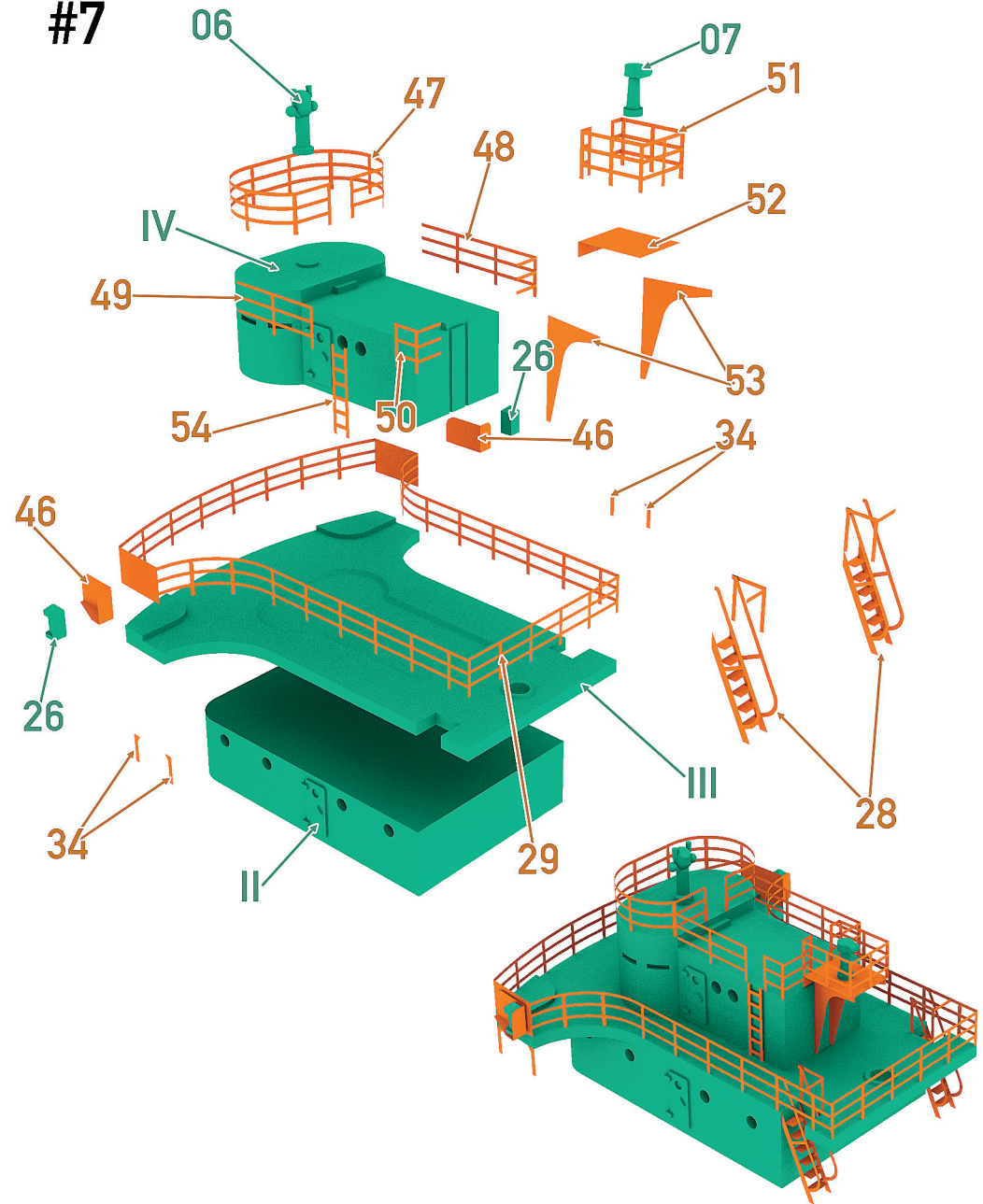

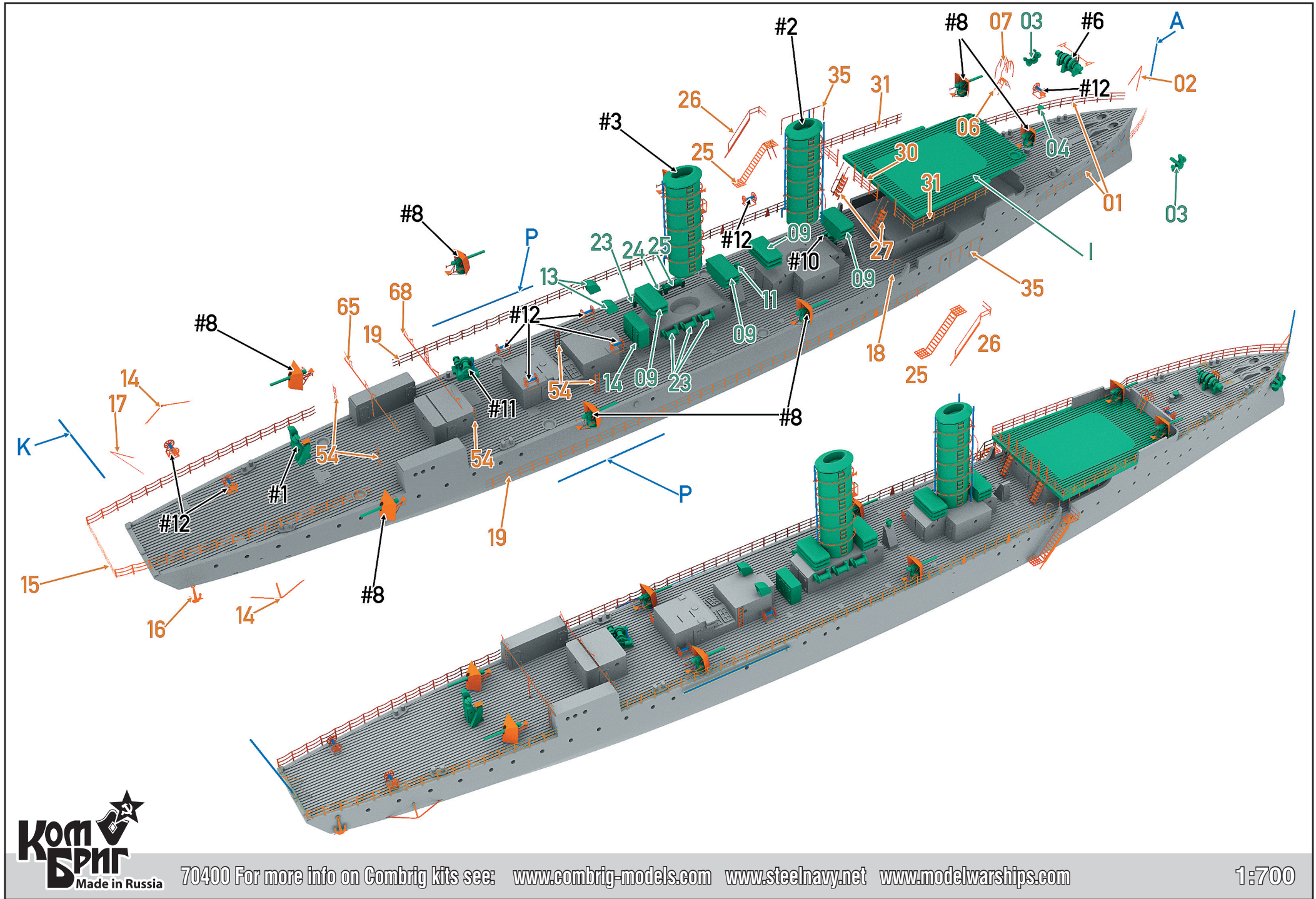

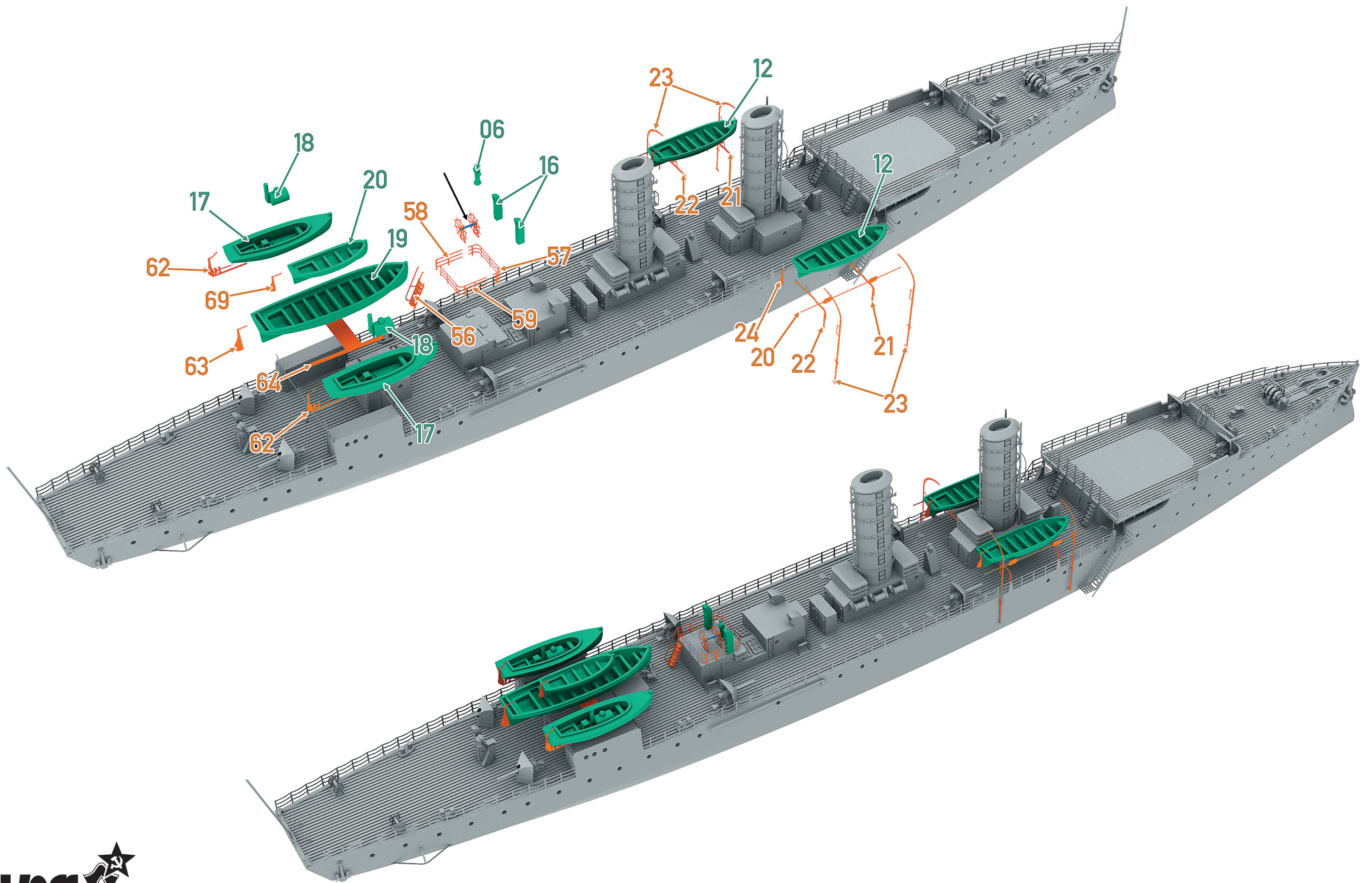

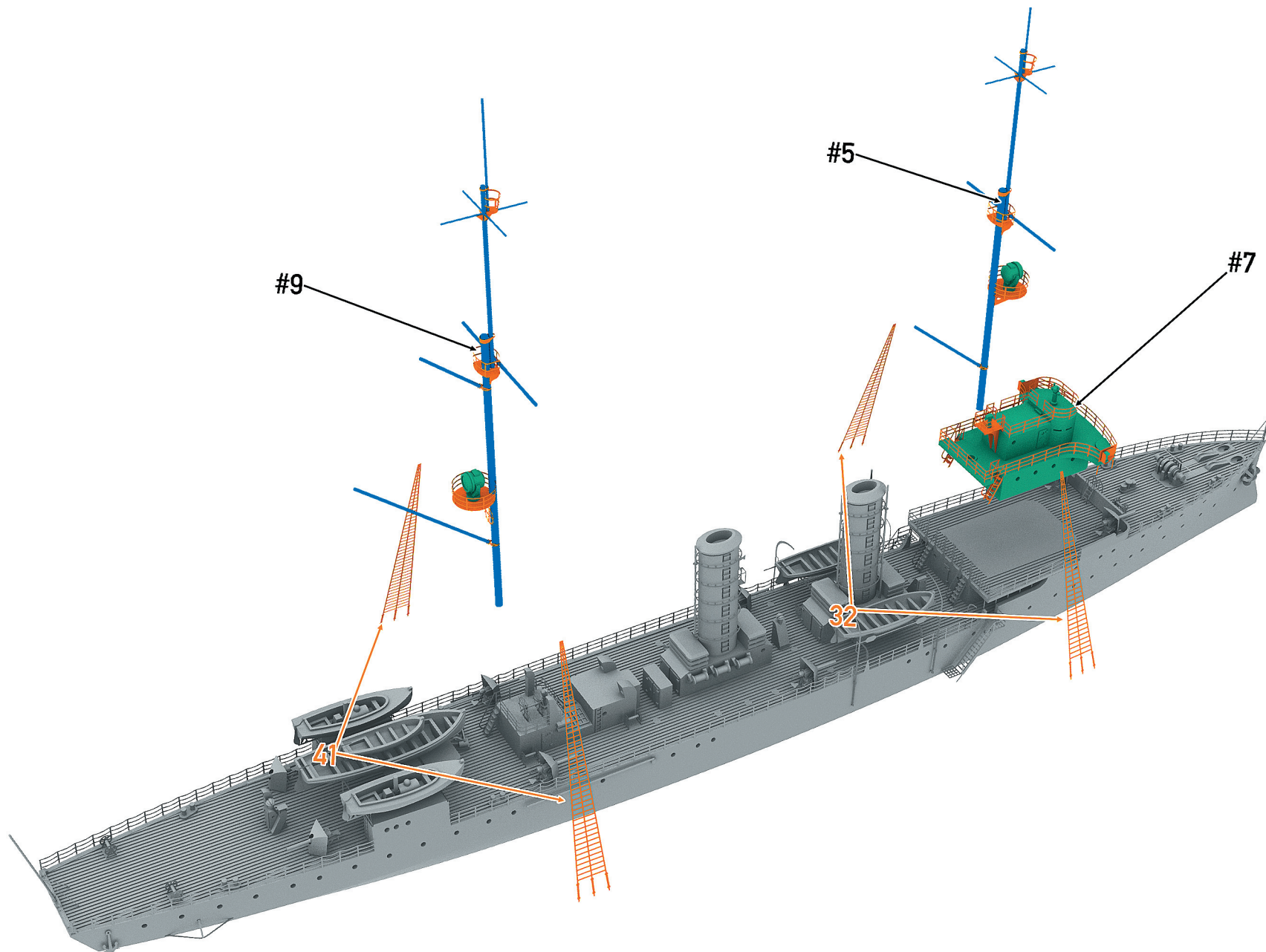

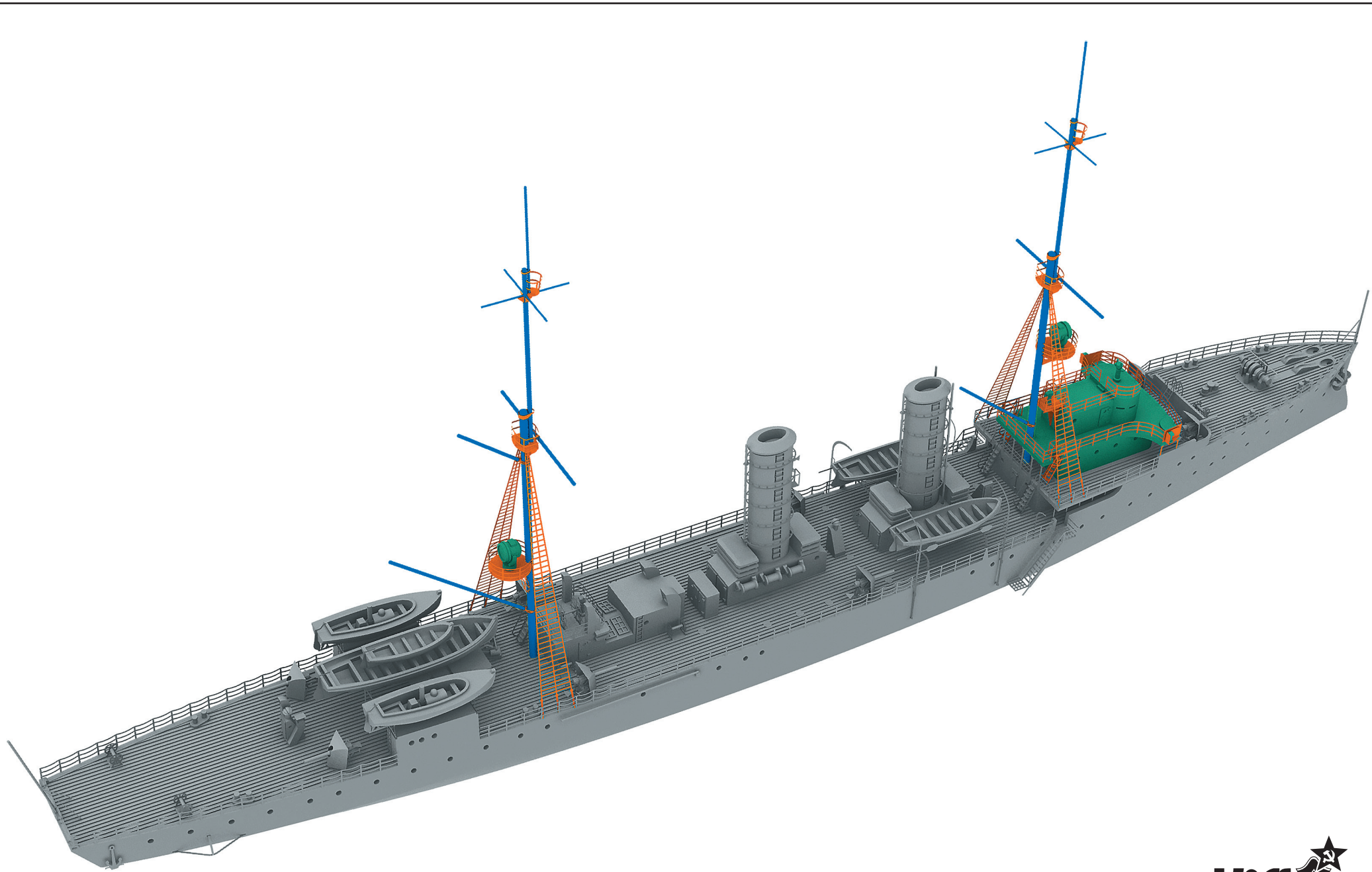

70400 For more info on Combrig kits see: www.combrig-models.com www.steelnavy.net www.modelwarships.com 1:700

**Ком
Бриг**
Made in Russia