

SMS «KOLBERG»

Protected cruiser, 1910

KOLBERG

Бронепалубный крейсер

«КОЛЬБЕРГ»

Германия, 1910

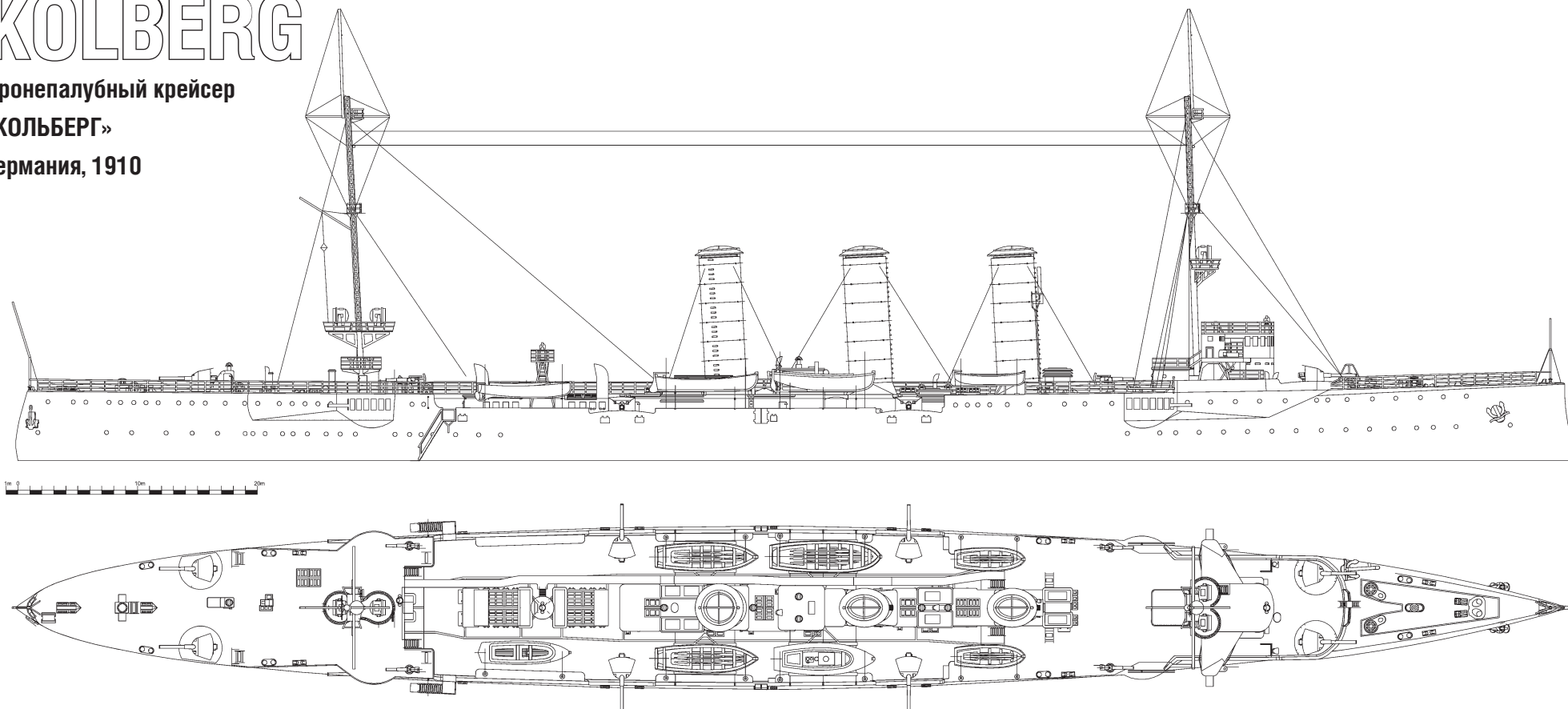

Один из четырех бронепалубных крейсеров одноименного типа. Несмотря на внешнее сходство все корабли оснащались разными энергетическими установками. «Кольберг» получил паровые турбины фирмы «Melm & Pfenniger», которые вращали четыре трехлопастных гребных винта.

В январе 1915 года участвовал в битве у Доггер-банки, затем в августе — в попытке форсирования Рижского залива. В ночь с 10 на 11 ноября 1916 года прикрывал выход 10-й флотилии эскадренных миноносцев, закончившийся гибелью большей части ее состава на русских минах. В 1917 году участвовал в Моонзунд-

ской операции, в 1918 году — во вторжении в Финляндию и попытке захватить корабли русского флота в Гельсингфорсе.

После окончания Первой мировой войны, в 1920 году передан в состав французского флота, в котором под названием «Кольмар» прослужил до 1929 года.

**Ком
Бриг**
Made in Russia

70528 For more info on Combrig kits see: www.combrig-models.com www.steelnavy.net www.modelwarships.com

1:700

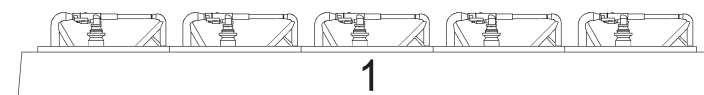
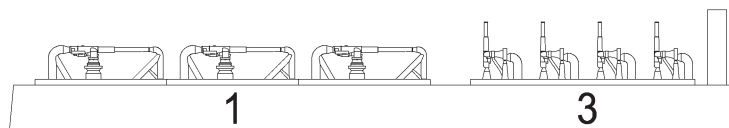
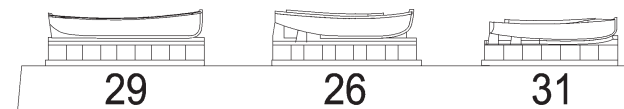
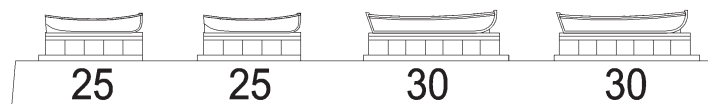
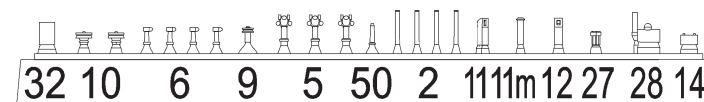
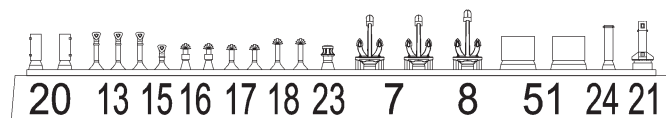
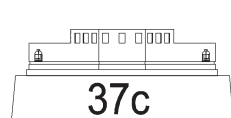
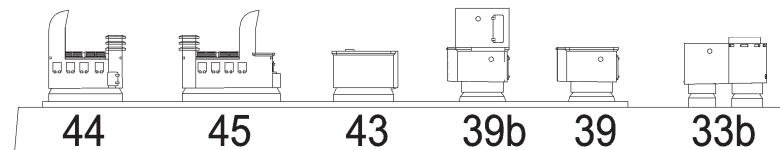
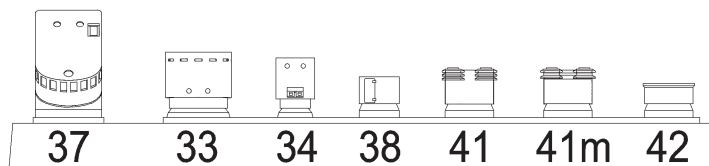
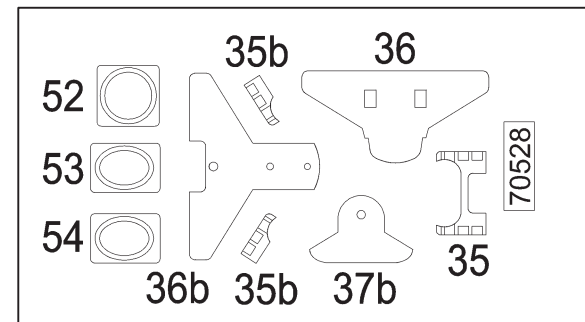
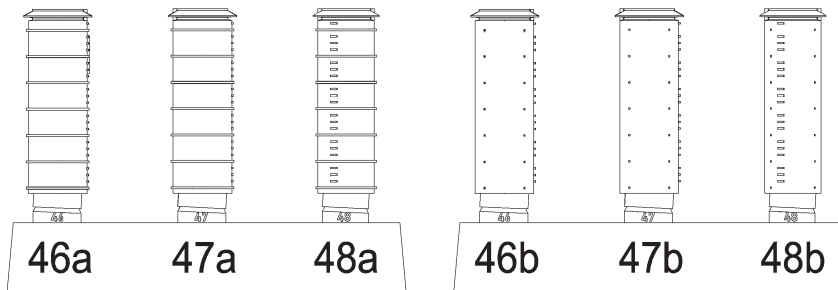
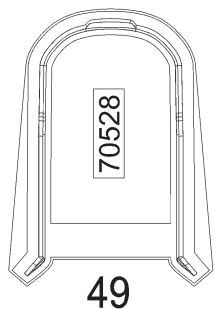

70528 SMS Kolberg 1910

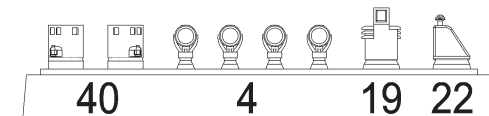

 To download the assembly instructions in PDF (high resolution) please visit www.combrig-models.com
Please note that the assembly guide reflects the position of the parts when installed only, and not the exact order of the assembly.

70528 For more info on Combrig kits see: www.combrig-models.com www.steelnavy.net www.modelwarships.com

1:700



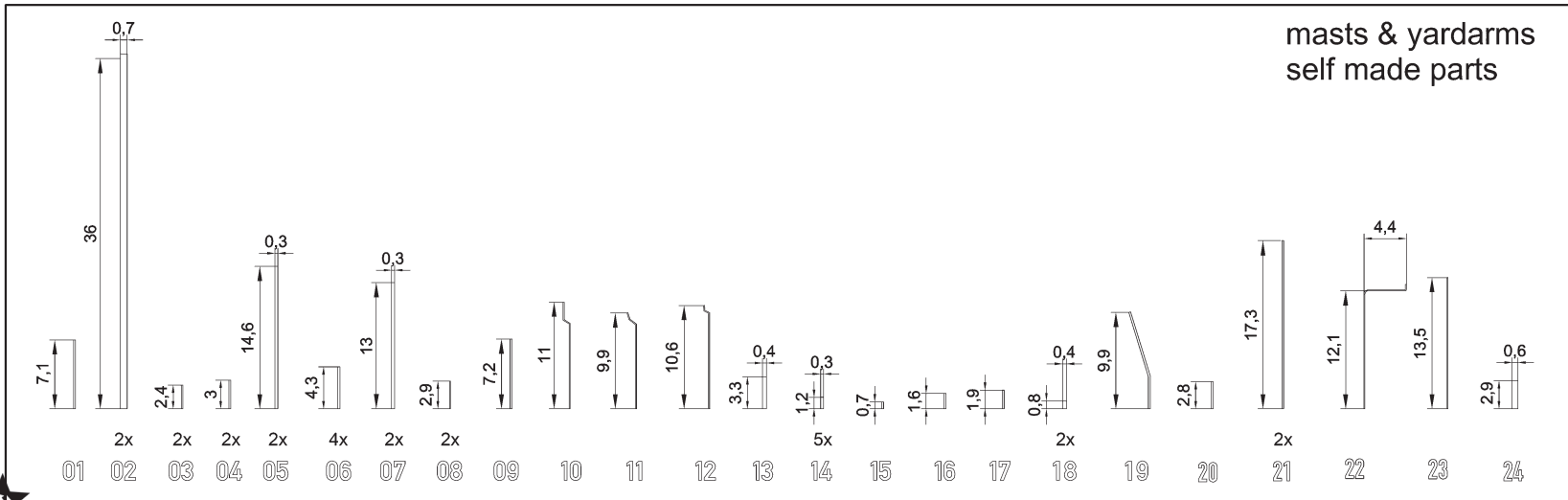
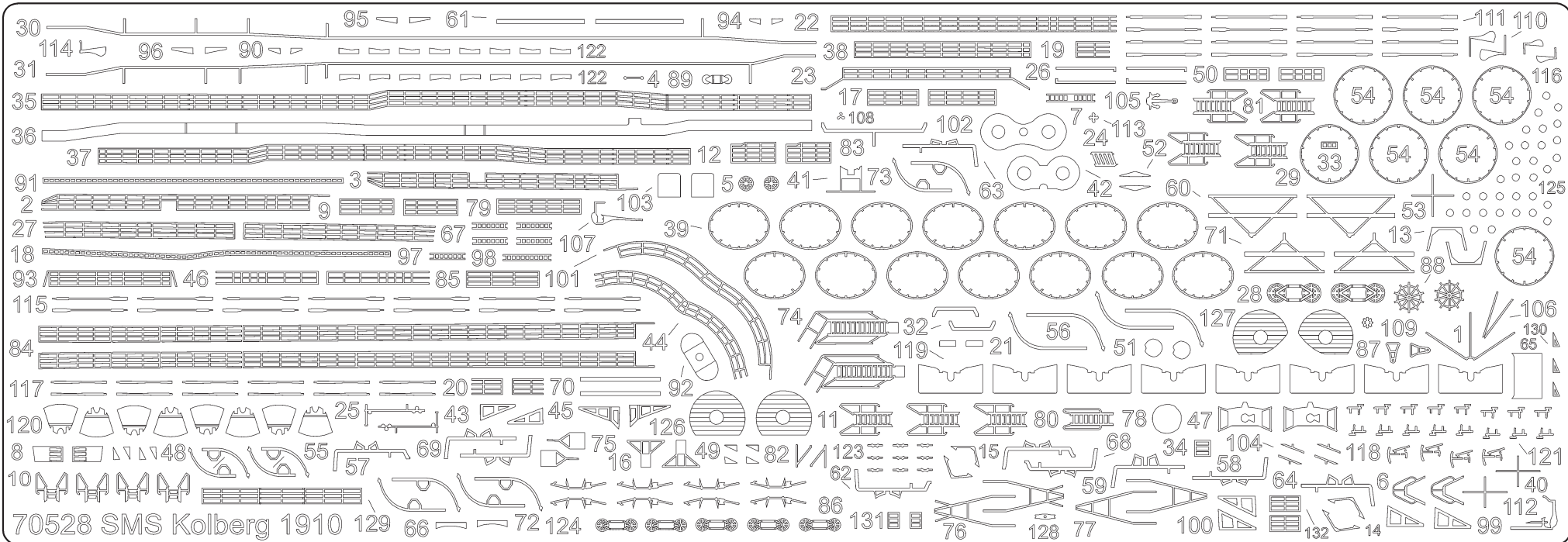

70528 For more info on Combrig kits see: www.combrig-models.com www.steelnavy.net www.modelwarships.com

1:700

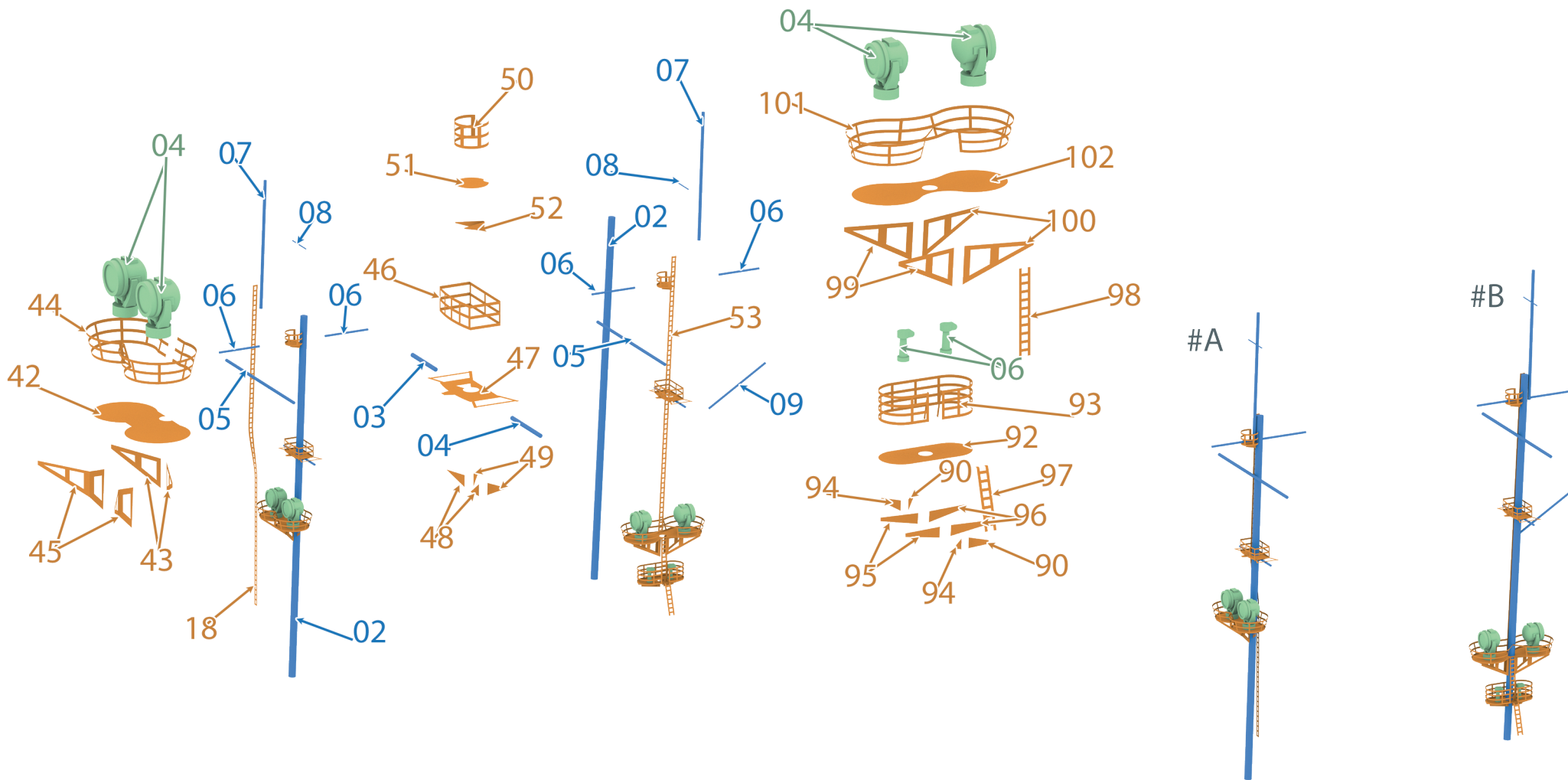

70528 For more info on Combrig kits see: www.combrig-models.com www.steelnavy.net www.modelwarships.com

1:700



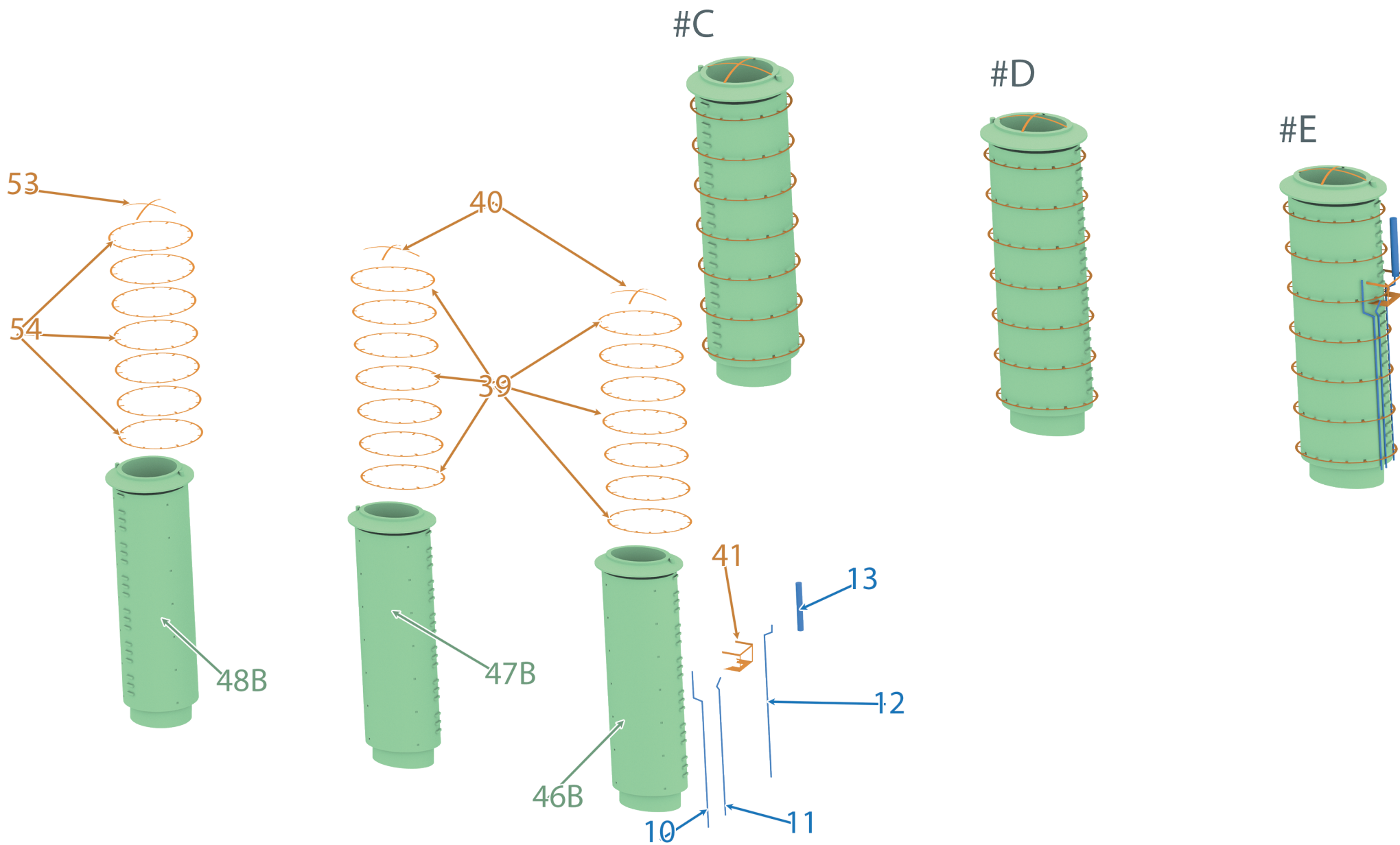

На момент ввода в строй
At the time of commissioning

#E

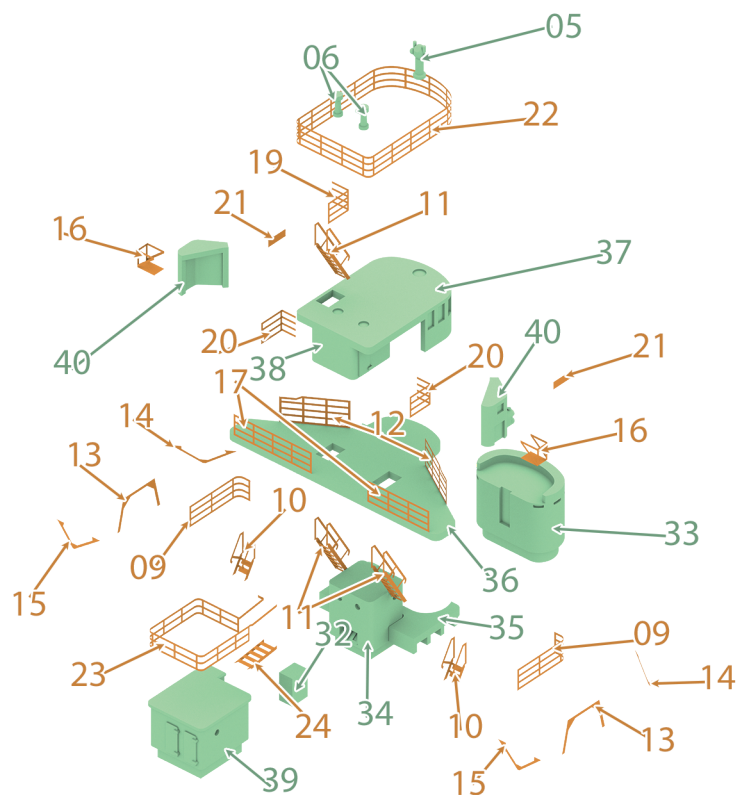
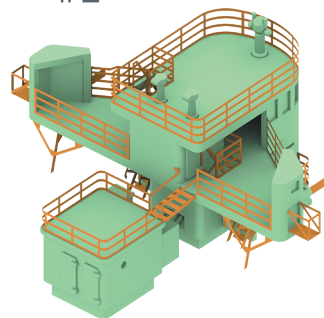

По состоянию на 1914 год
As of 1914

#E

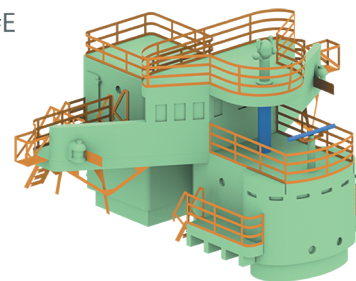

#E

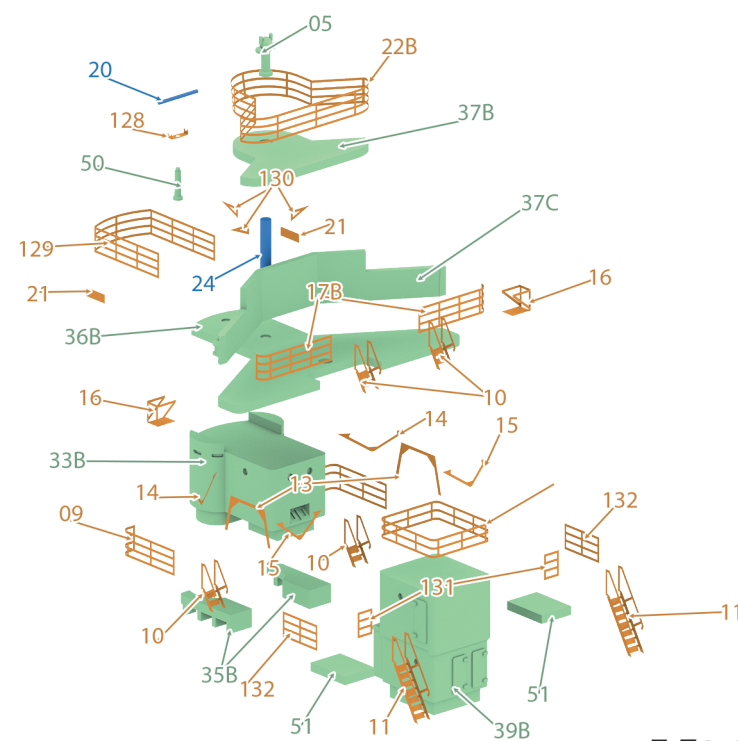
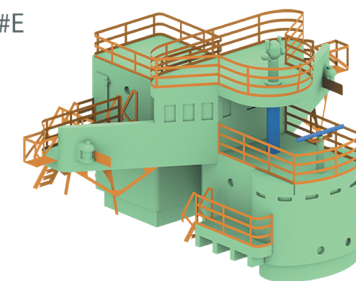

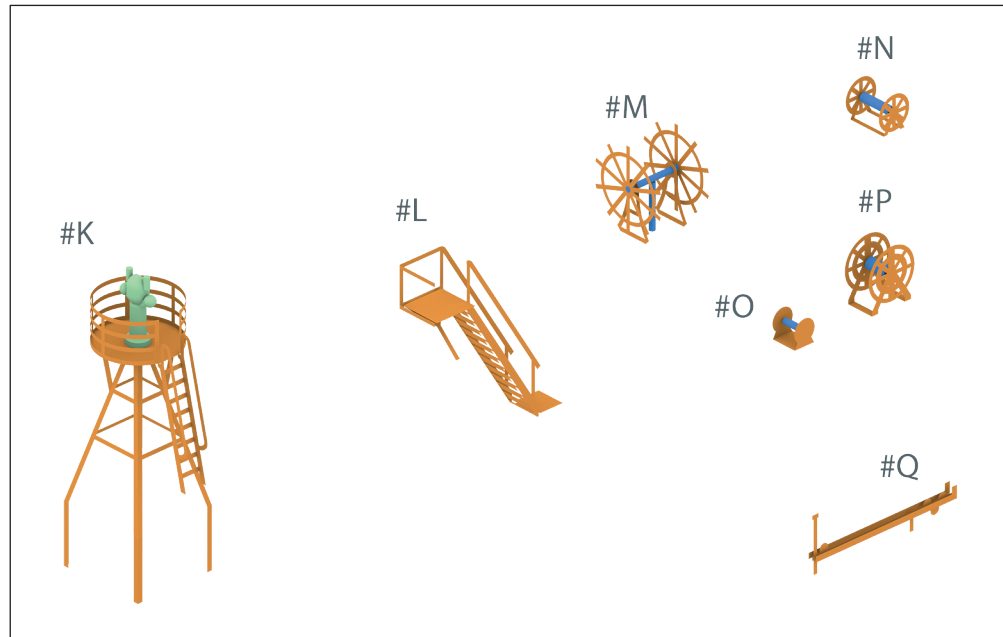
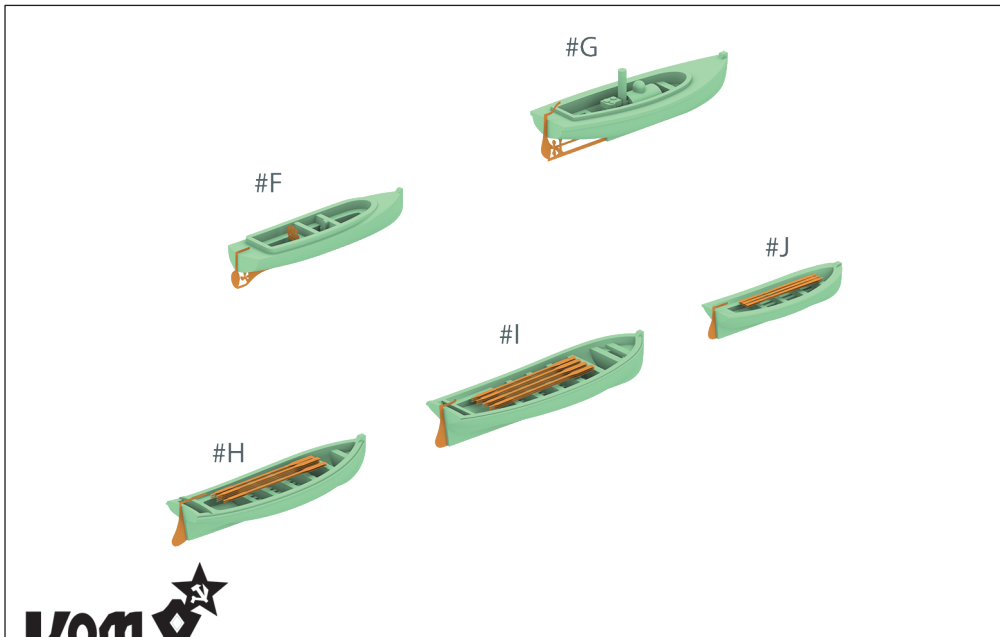
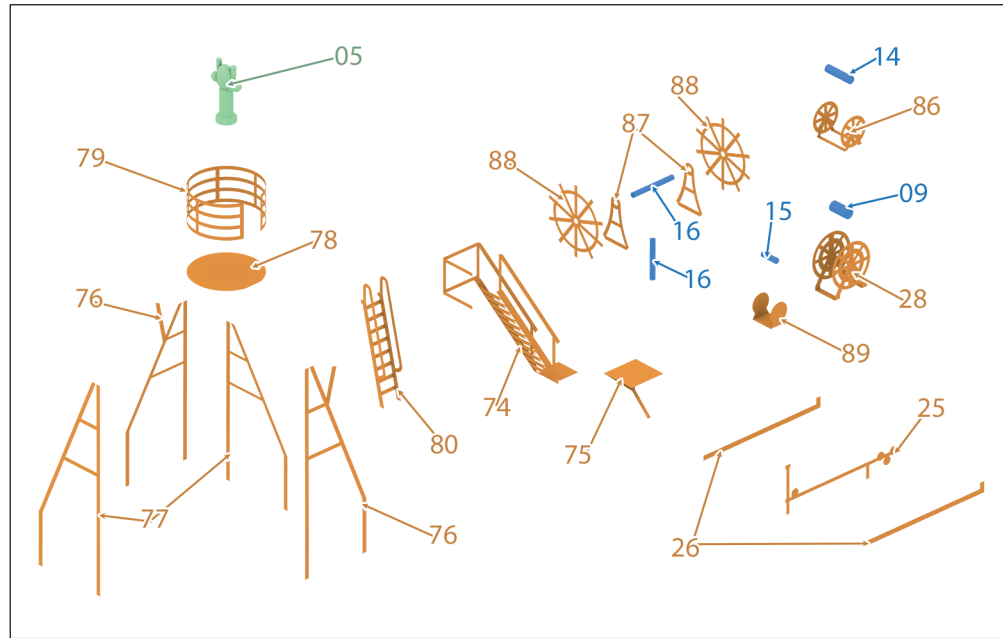
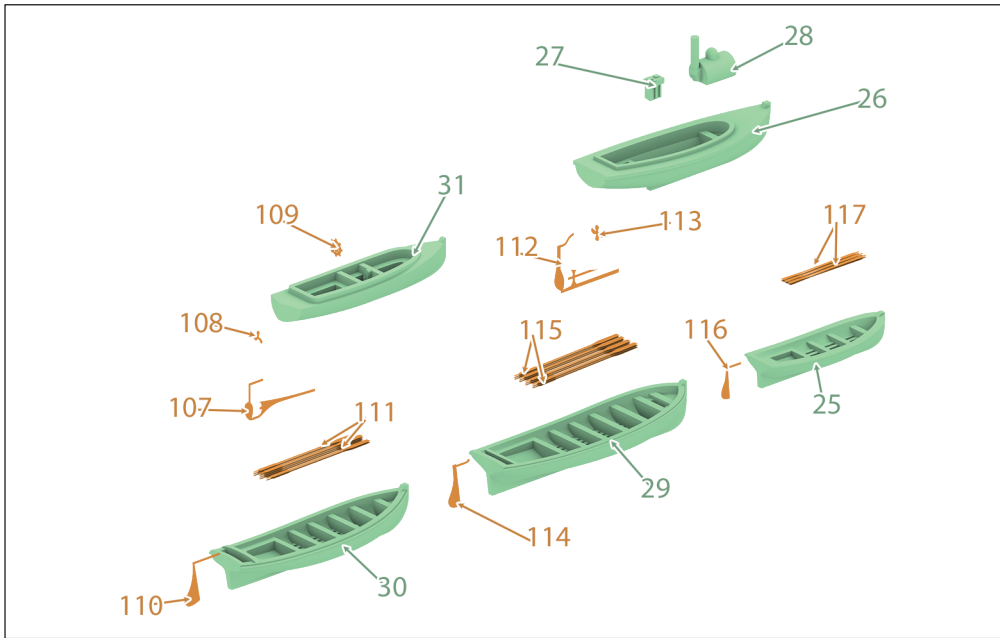

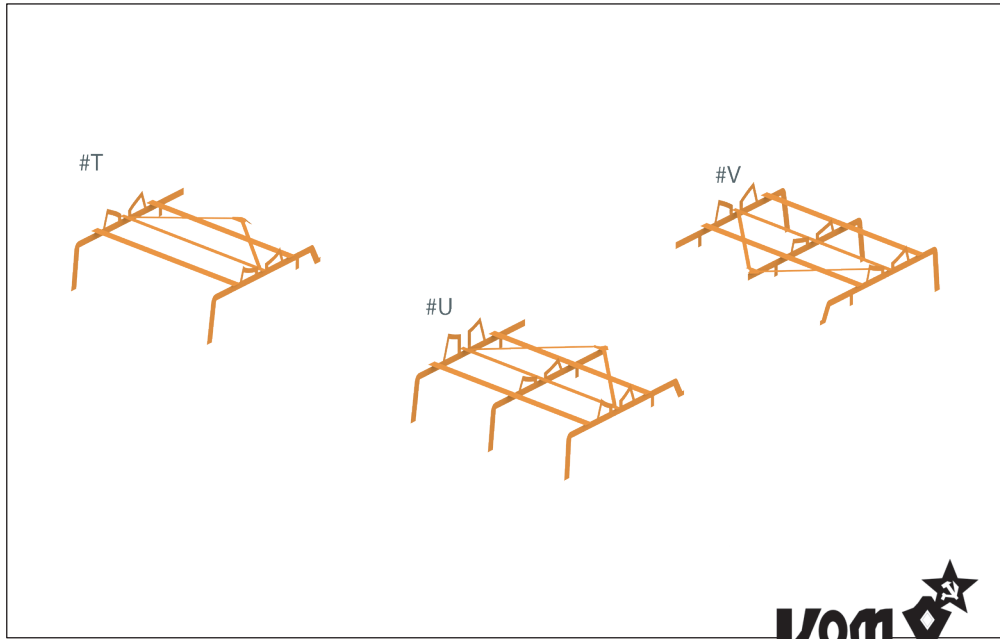
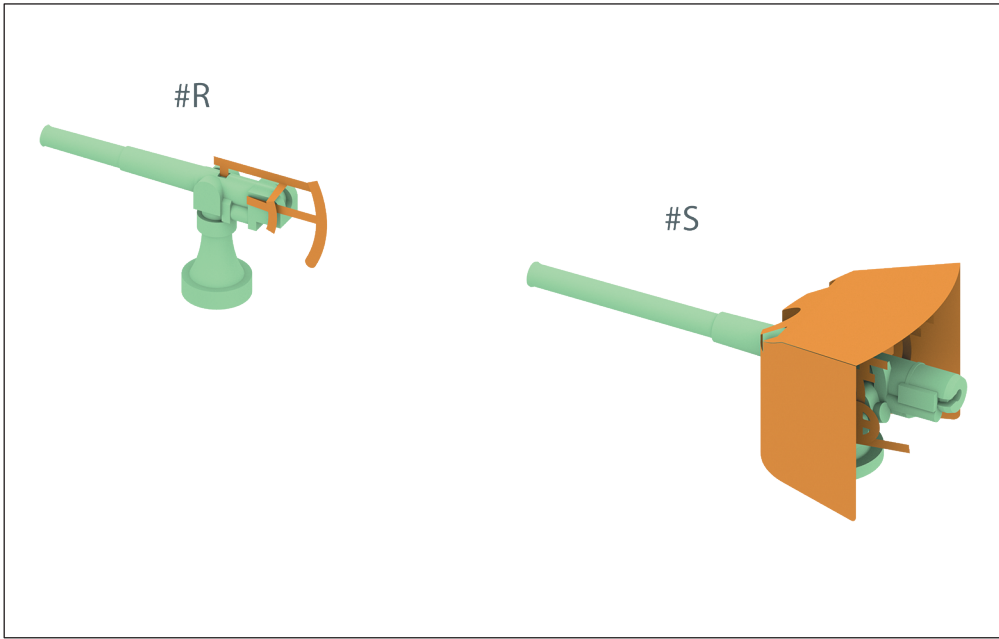
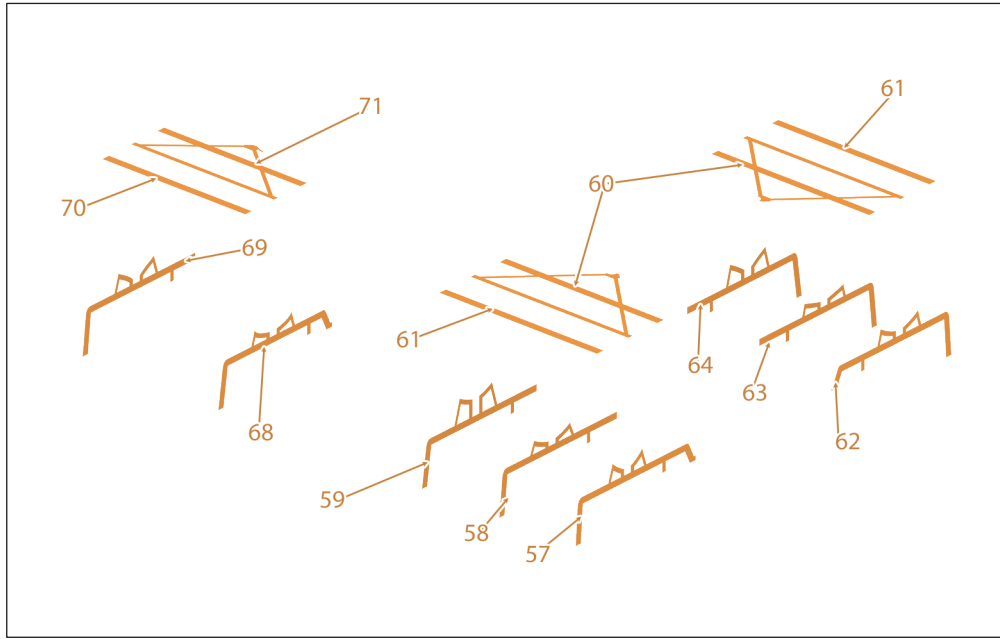
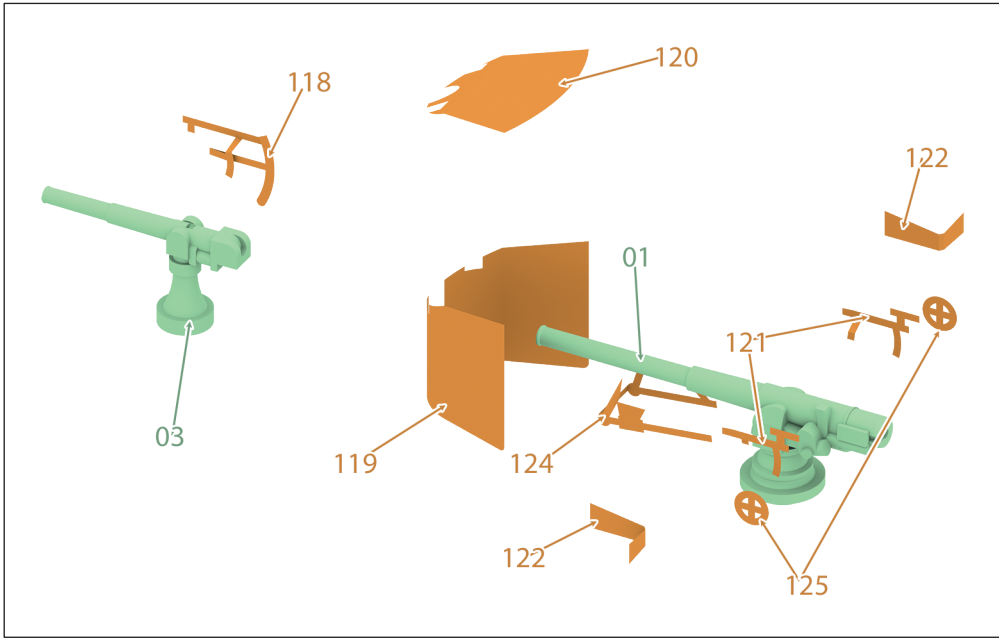

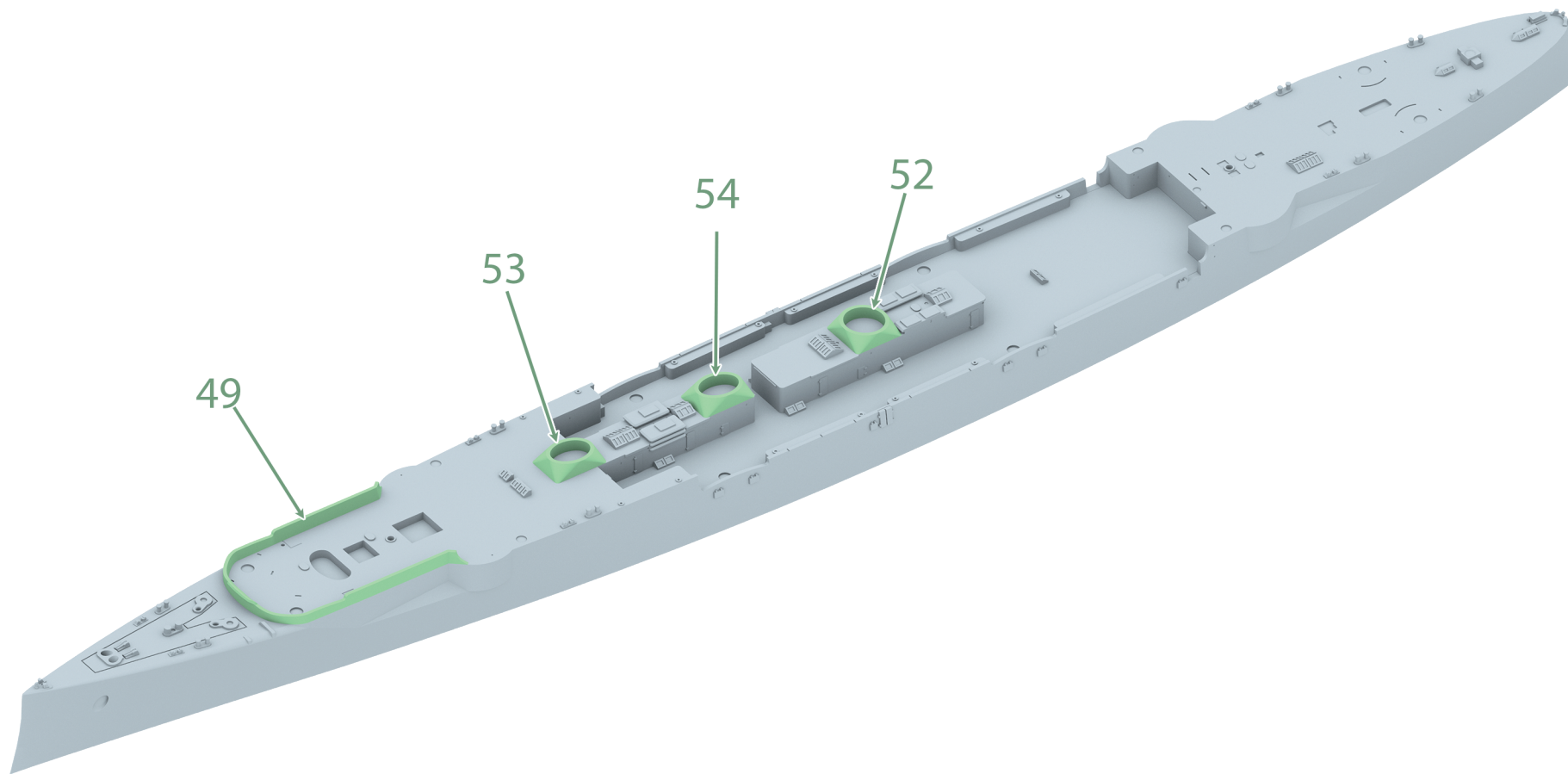

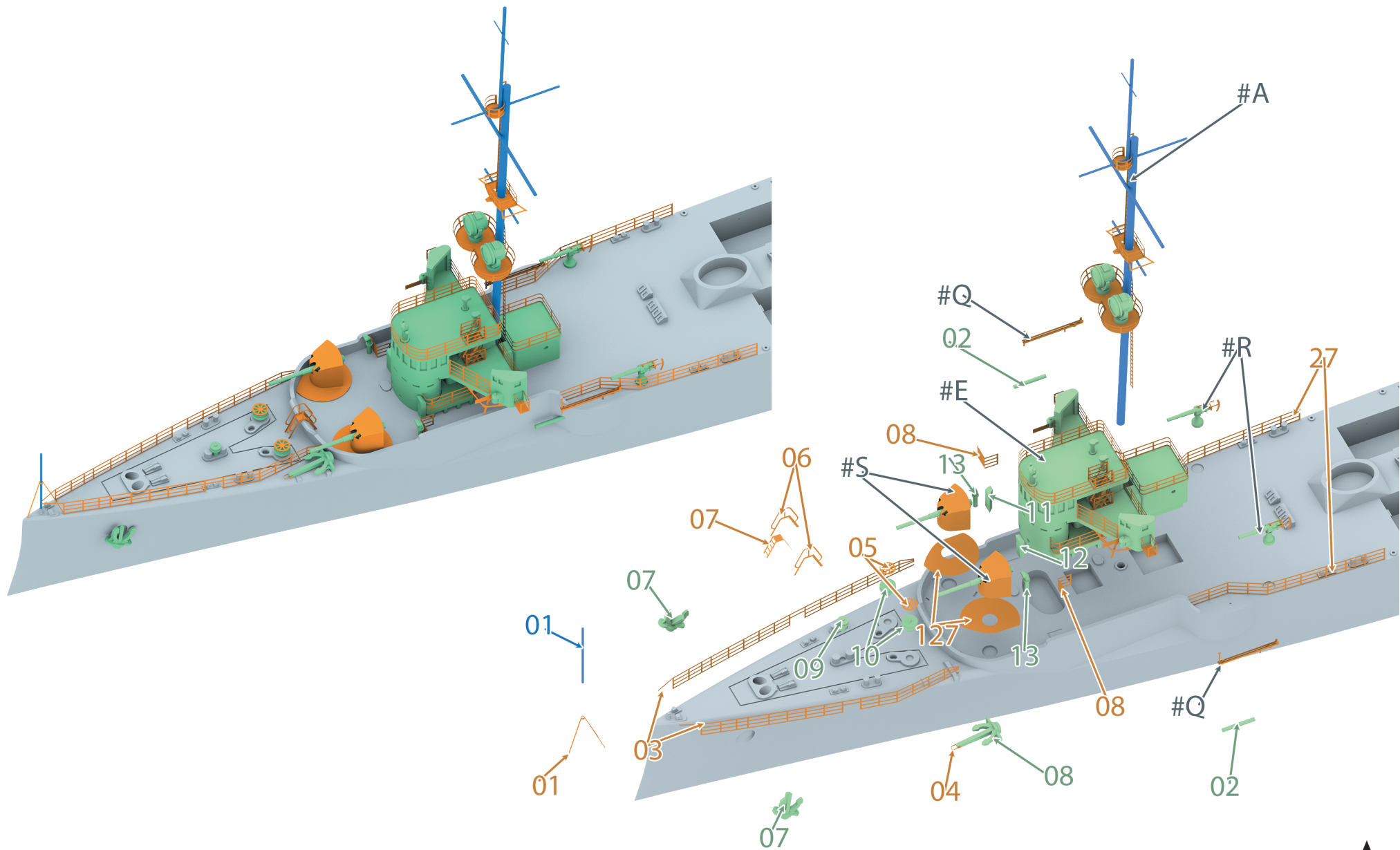

70528 For more info on Combrig kits see: www.combrig-models.com www.steelnavy.net www.modelwarships.com

1:700



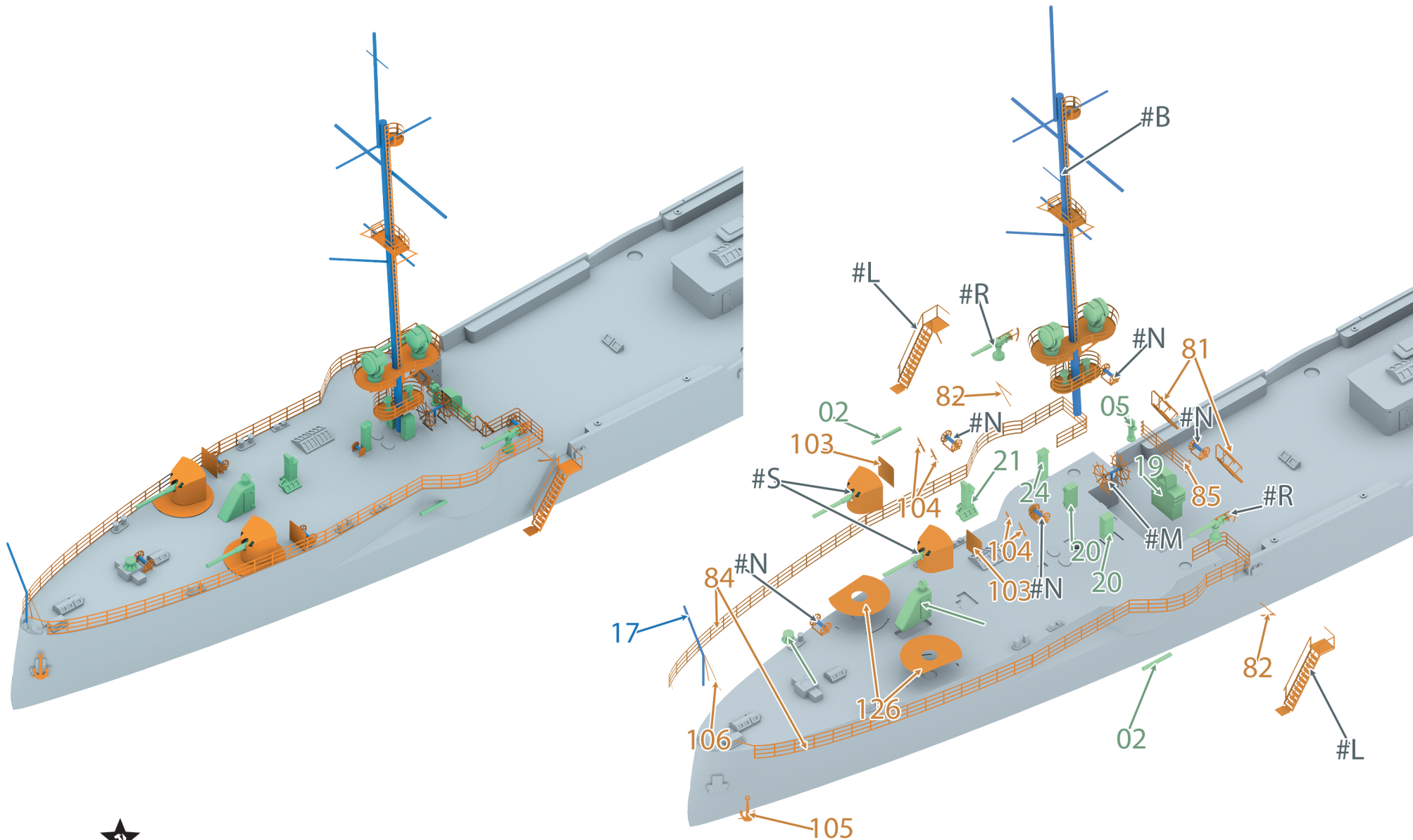

70528 For more info on Combrig kits see: www.combrig-models.com www.steelnavy.net www.modelwarships.com

1:700

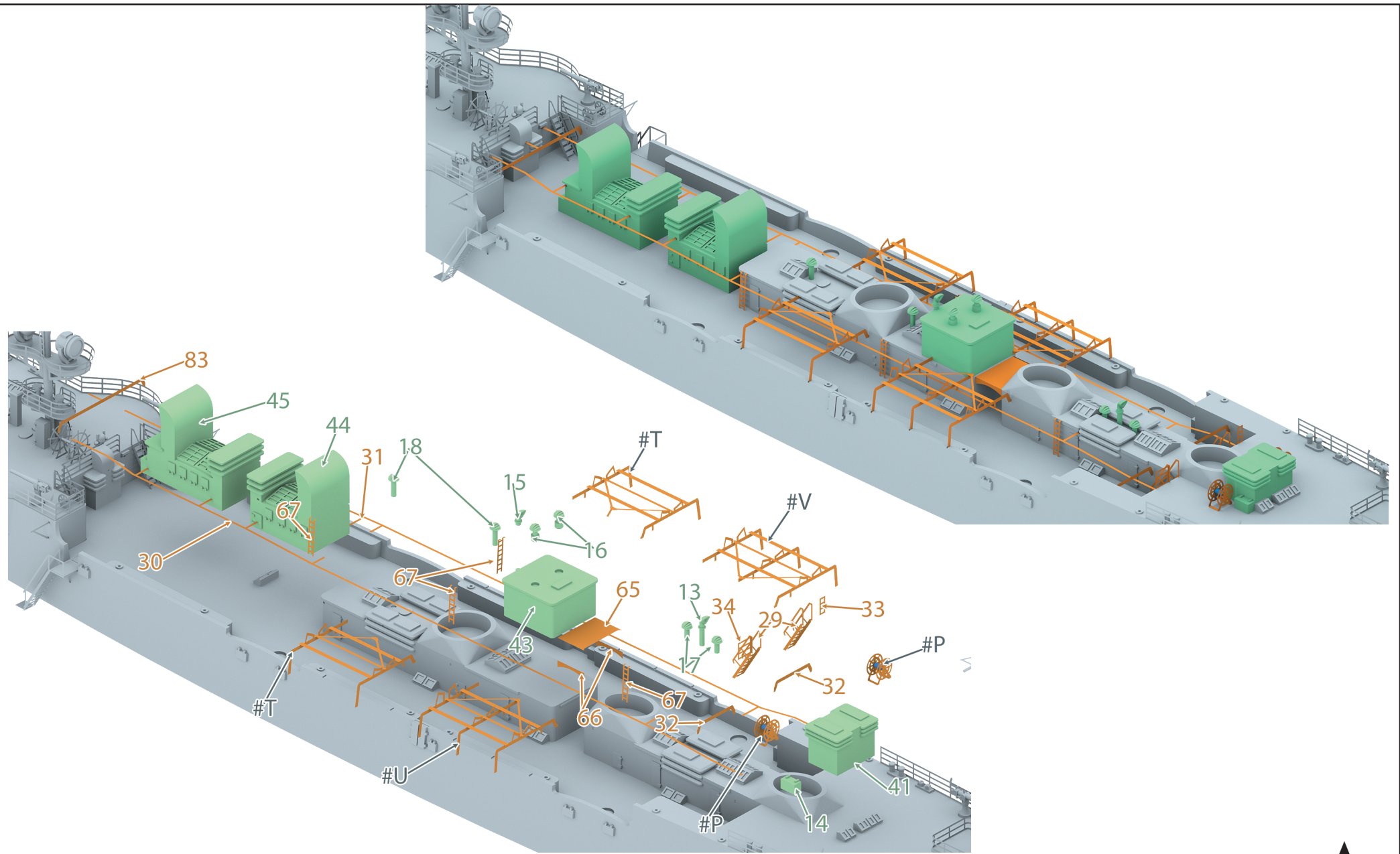

70528 For more info on Combrig kits see: www.combrig-models.com www.steelnavy.net www.modelwarships.com

1:700



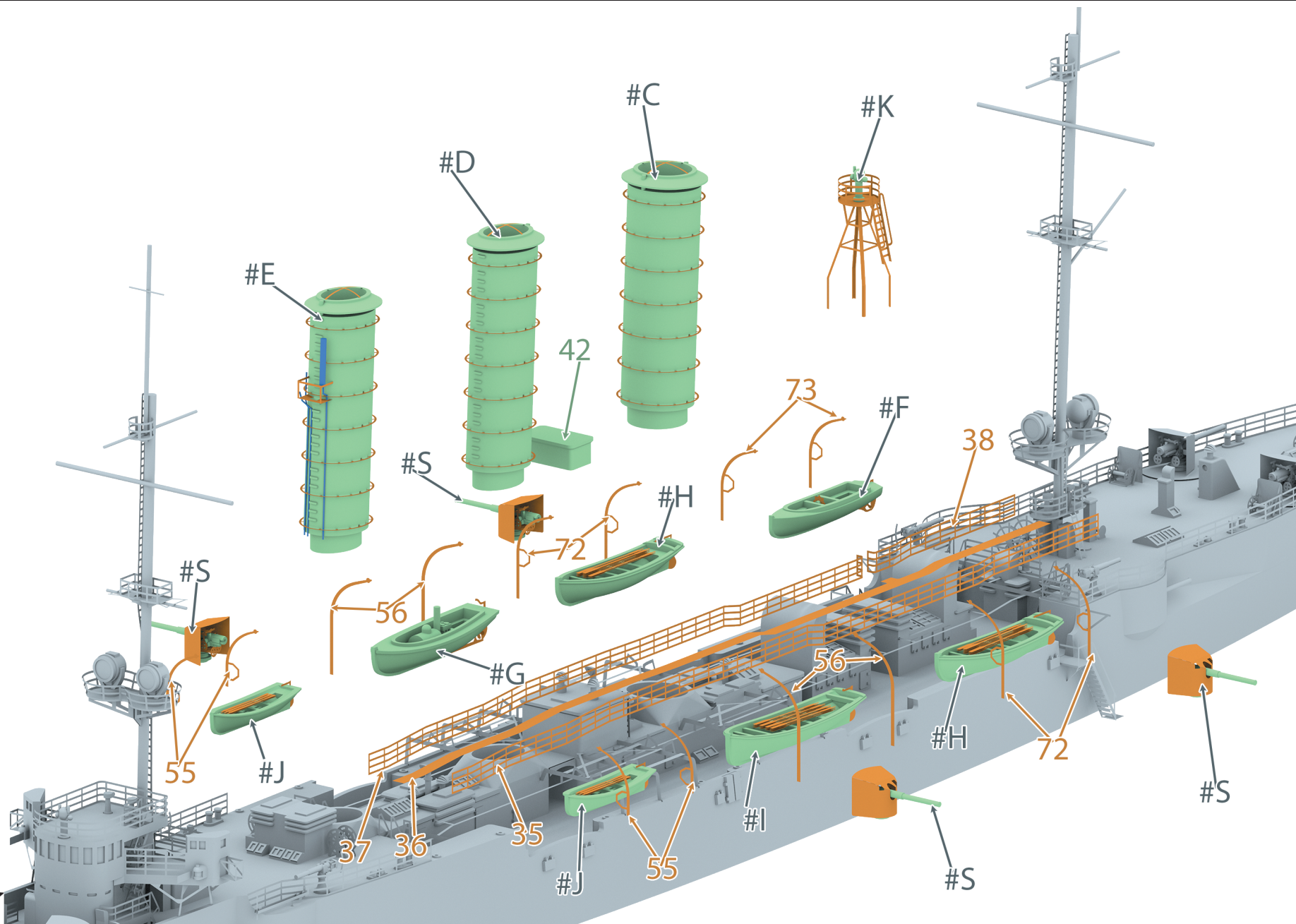

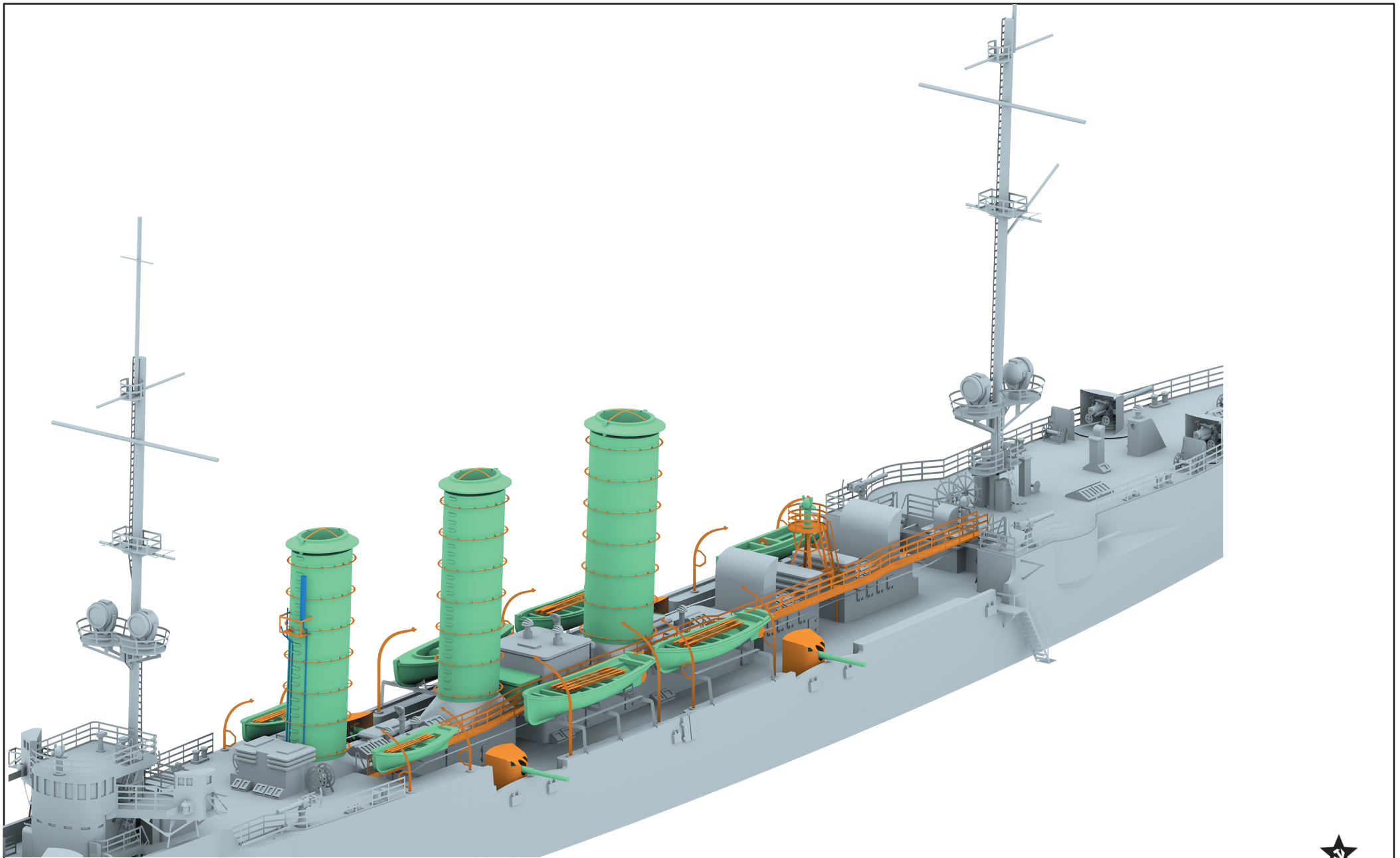

70528 For more info on Combrig kits see: www.combrig-models.com www.steelnavy.net www.modelwarships.com

1:700



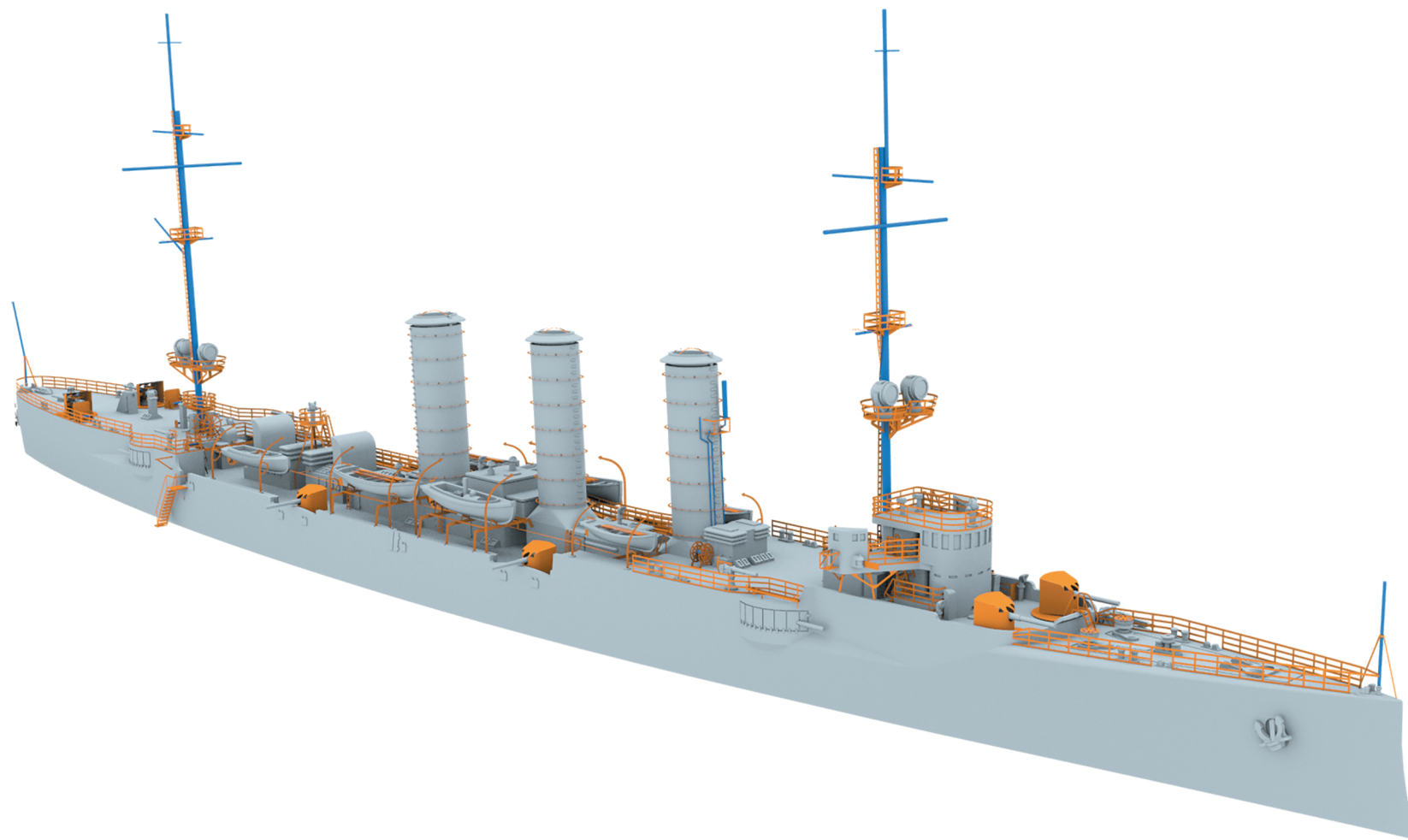

70528 For more info on Combrig kits see: www.combrig-models.com www.steelnavy.net www.modelwarships.com

1:700

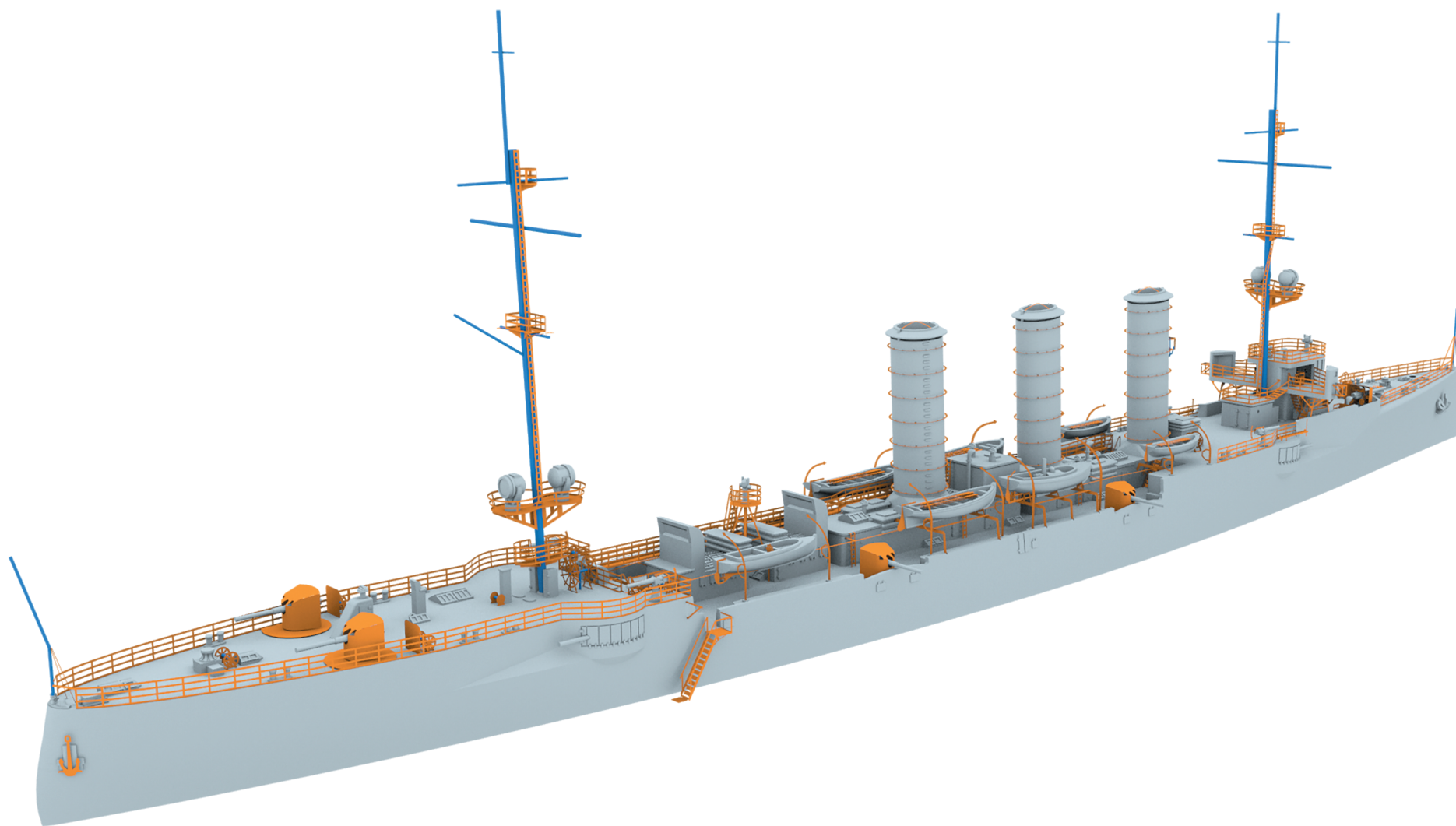

70528 For more info on Combrig kits see: www.combrig-models.com www.steelnavy.net www.modelwarships.com

1:700

