

SMS «MAINZ»

Protected cruiser, 1909

MAINZ

Бронепалубный крейсер

«МАЙНЦ»

Германия, 1909

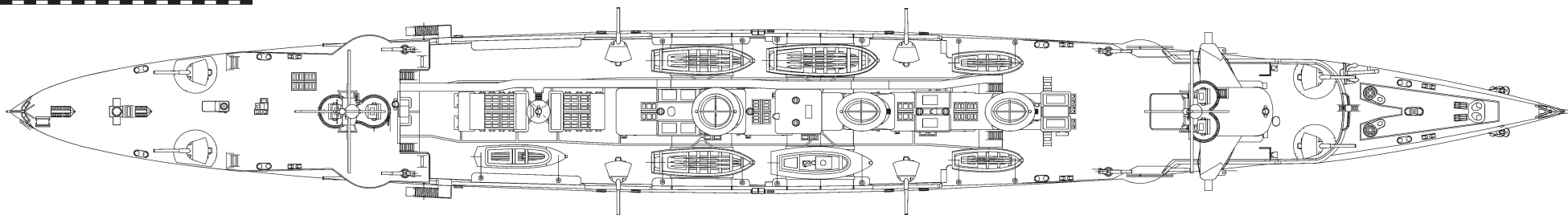
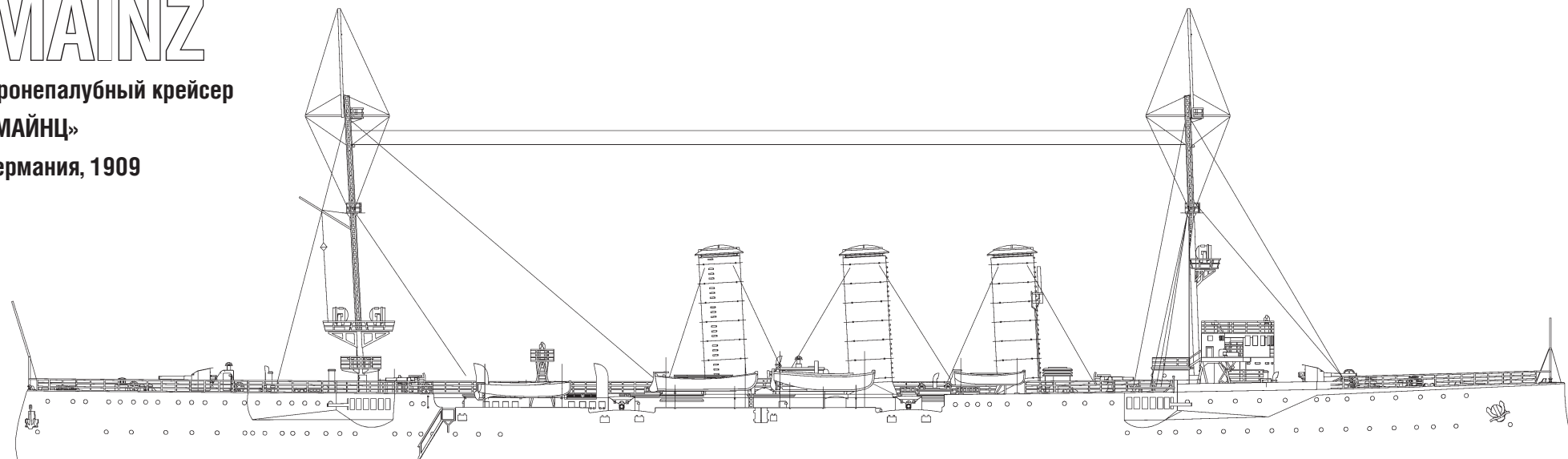

Один из четырех крейсеров типа «Кольберг». Несмотря на внешнее сходство все корабли оснащались разными энергетическими установками. «Майнц» получил паровые турбины фирмы «AEG-Curtiss», которые вращали два трехлопастных гребных винта, что позволяло развивать скорость на 0,5 узла больше, чем однотипные крейсера.

28 августа 1914 года во время патрулирования в районе острова Гельголанд «Майнц» подвергся атаке британских эсминцев, поддержанных крейсерами «Арестьяза» и «Фирлесс». В ходе короткого боя крейсер получил множество артиллерийских и одно торпедное попадание. Начались пожары, внутрь корпуса поступило боль-

шое количество воды. Руль заклинило в положении 10° на левый борт, а левая турбина была разбита. В 12:50 «Майнц» спустил флаг. Уцелевших членов экипажа снял британский эсминец «Лурчер». Через некоторое время «Майнц» затонул. Общие потери экипажа крейсера составили 89 человек.

**Ком
БРИГ**
Made in Russia

70529 For more info on Combrig kits see: www.combrig-models.com www.steelnavy.net www.modelwarships.com

1:700

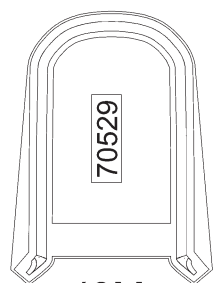

49M

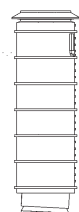

46a

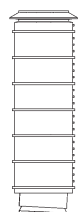

47a

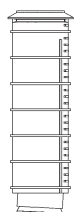

48a

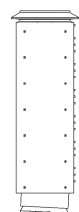

46b

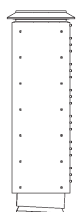

47b

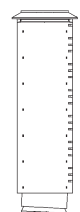

48b

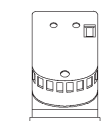
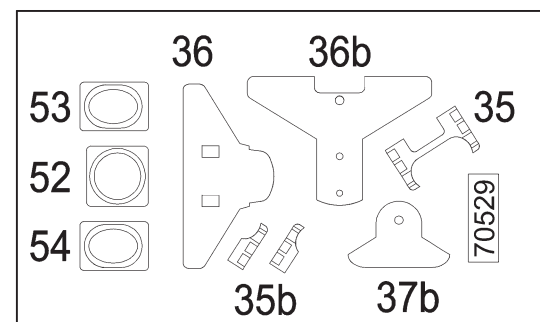

37



33



34



38



41



41m



42



44

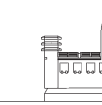

45

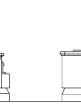

43

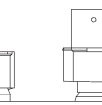

39b

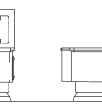

39



33b

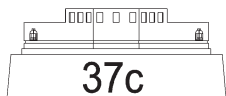

37c

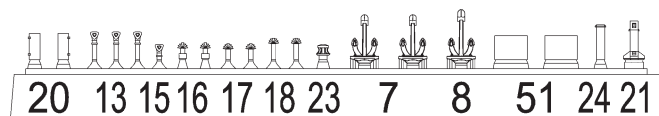

20 13 15 16 17 18 23 7 8 51 24 21

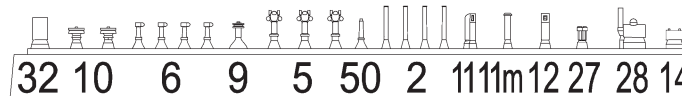

32 10 6 9 5 50 2 11 11m 12 27 28 14



25 25 30 30

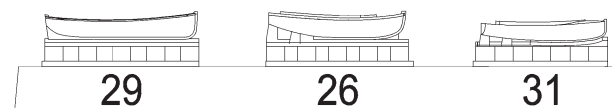

29 26 31

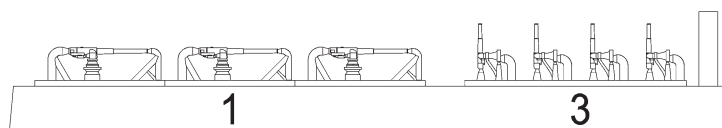

1 3

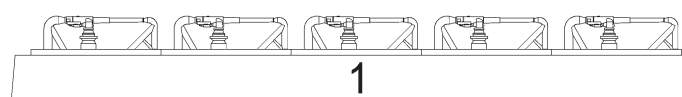

1

70529 SMS Mainz 1909

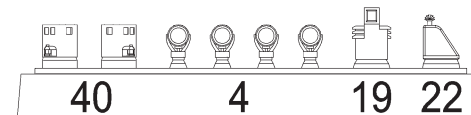

40 4 19 22

 To download the assembly instructions in PDF (high resolution) please visit www.combrig-models.com
Please note that the assembly guide reflects the position of the parts when installed only, and not the exact order of the assembly.

70529 For more info on Combrig kits see: www.combrig-models.com www.steelnavy.net www.modelwarships.com

1:700



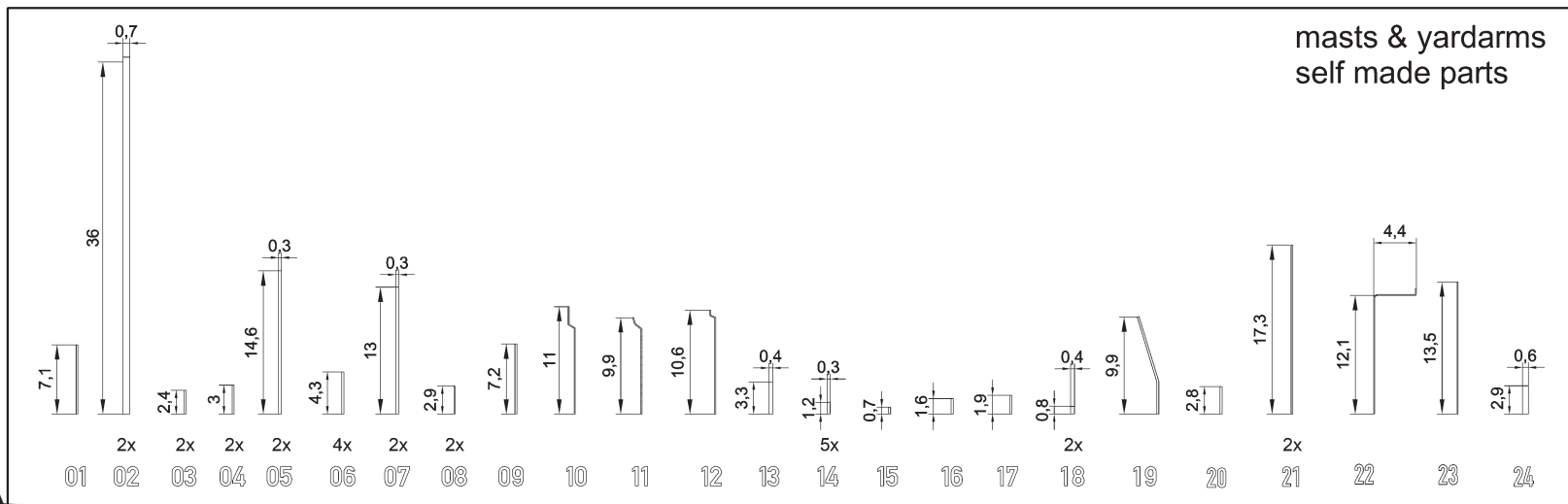
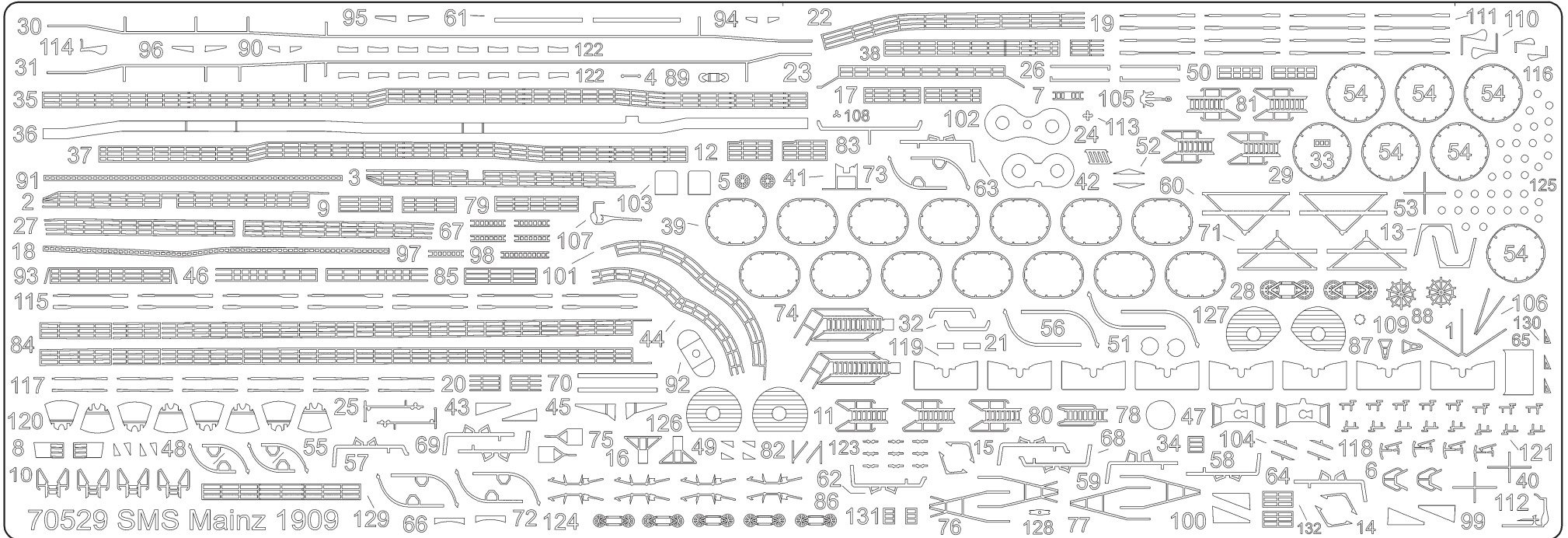

70529 For more info on Combrig kits see: www.combrig-models.com www.steelnavy.net www.modelwarships.com

1:700

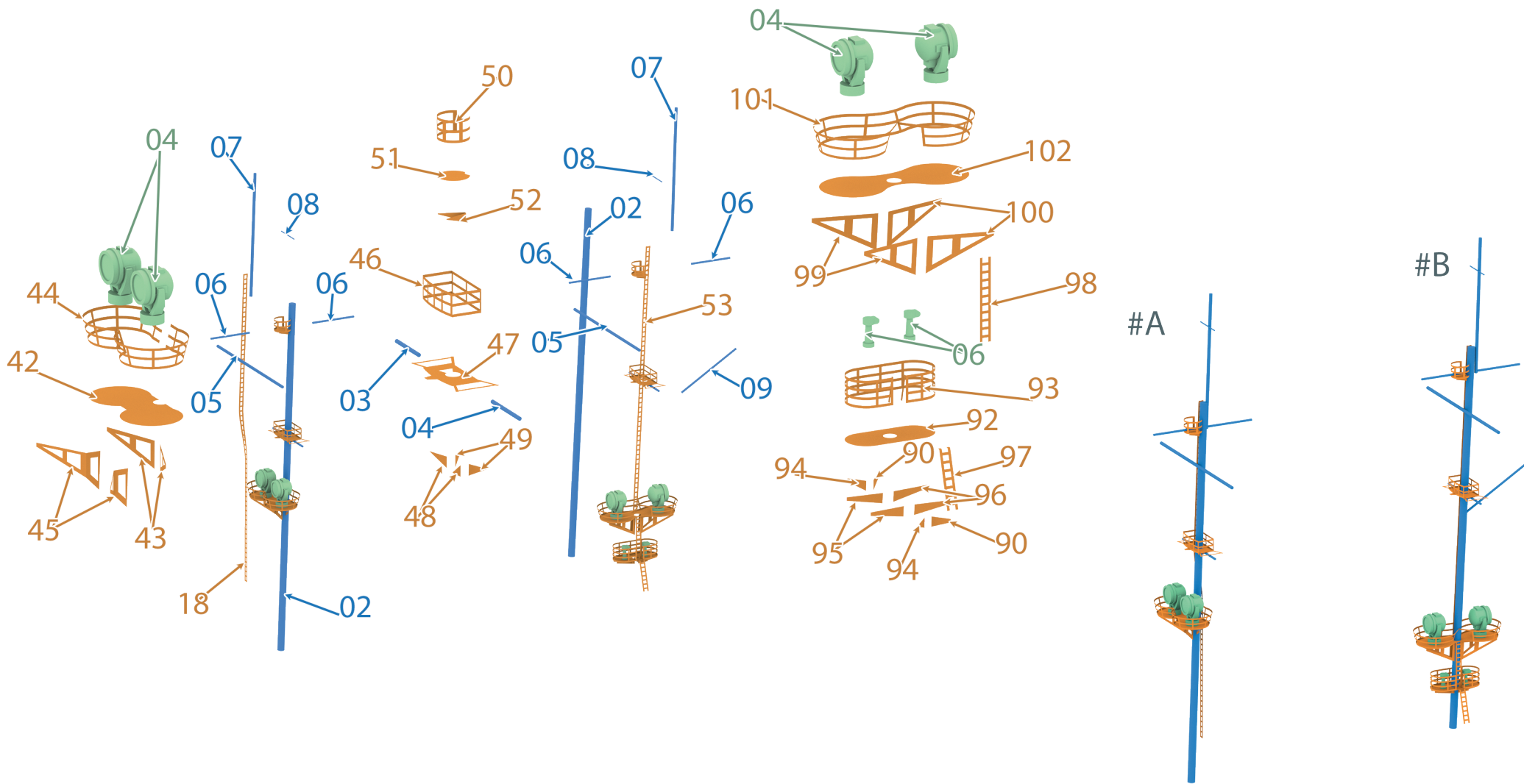

70529 For more info on Combrig kits see: www.combrig-models.com www.steelnavy.net www.modelwarships.com

1:700



#C

#D

#E

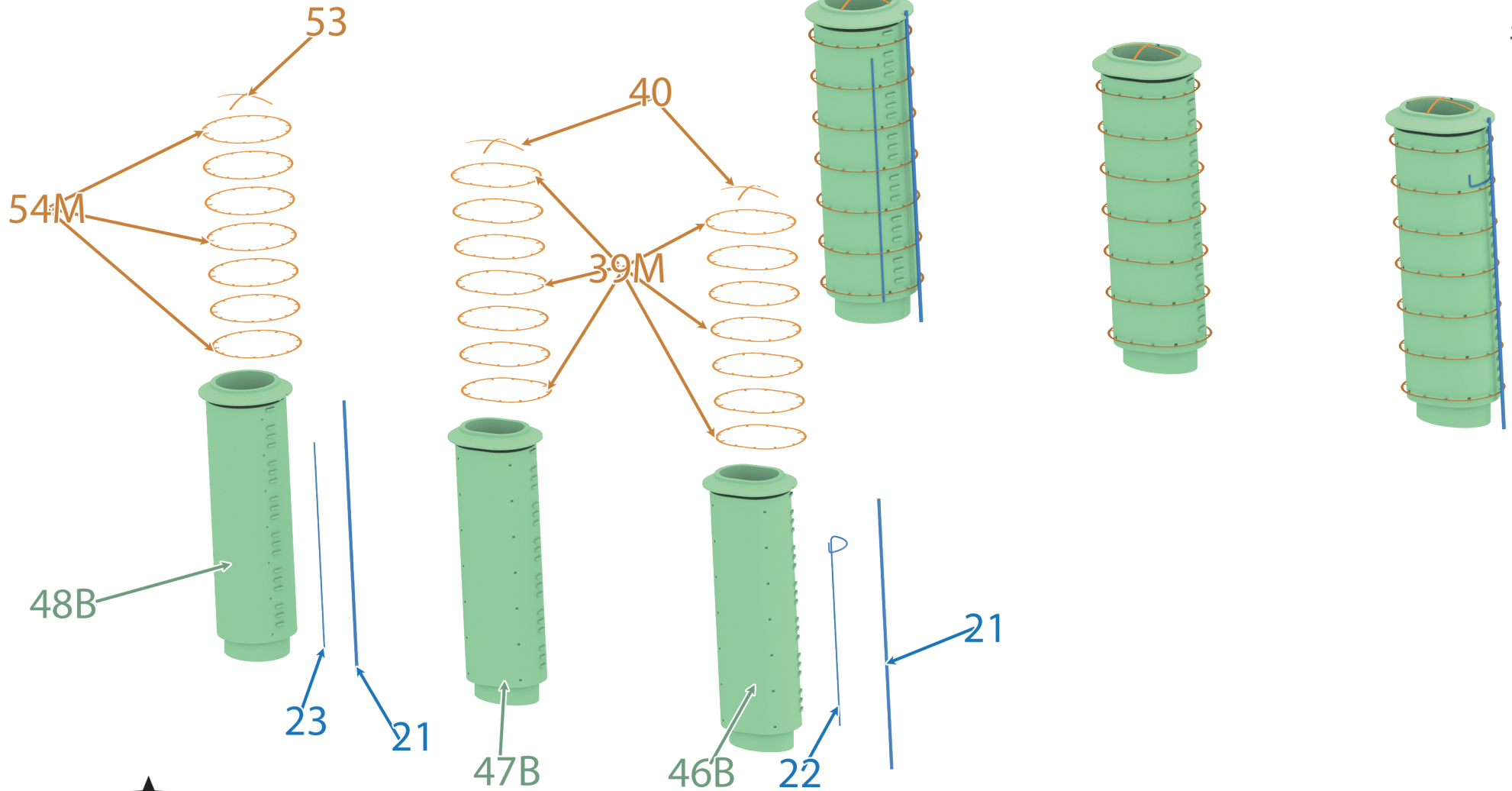

На момент ввода в строй
At the time of commissioning

#E

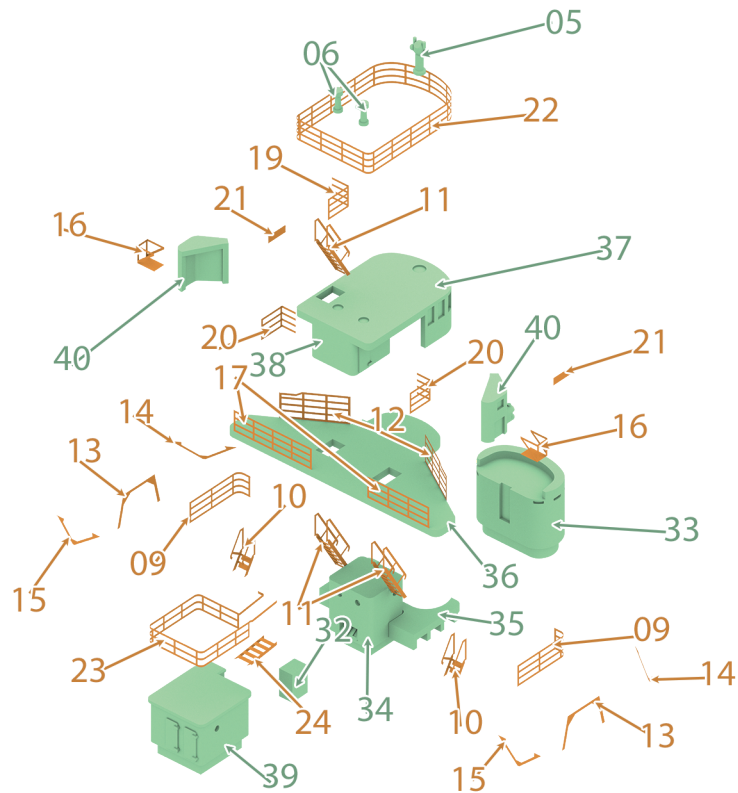
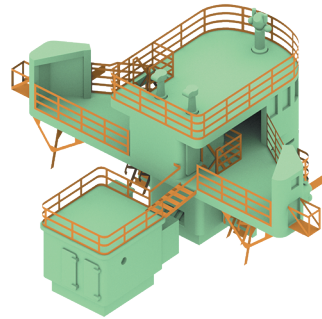

По состоянию на 1914 год
As of 1914

#E

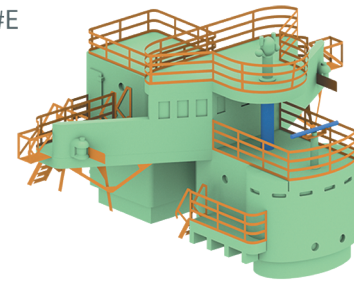

#E

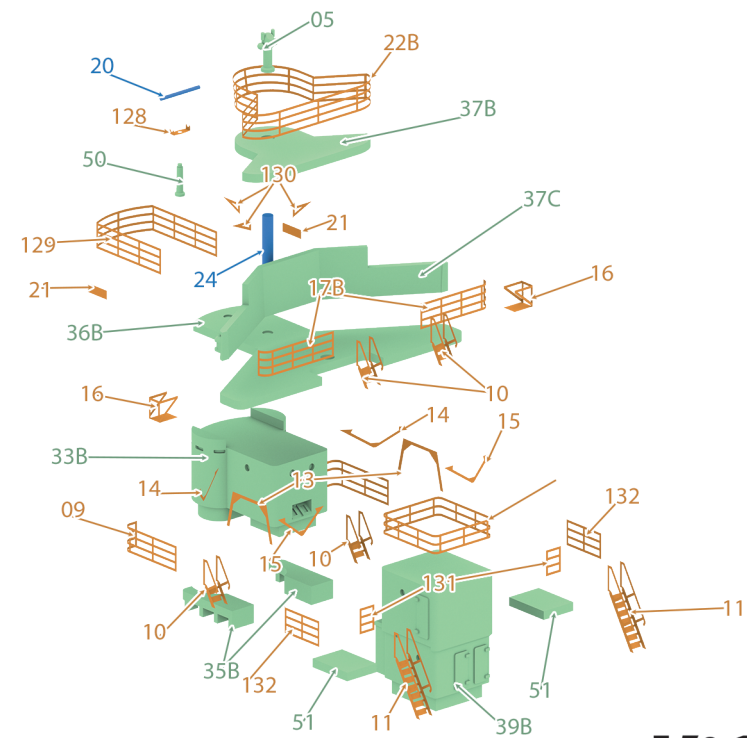
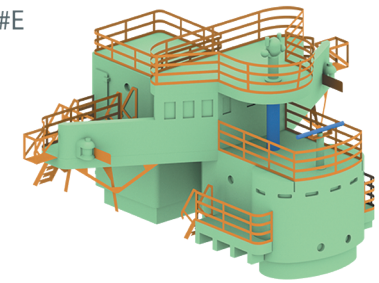

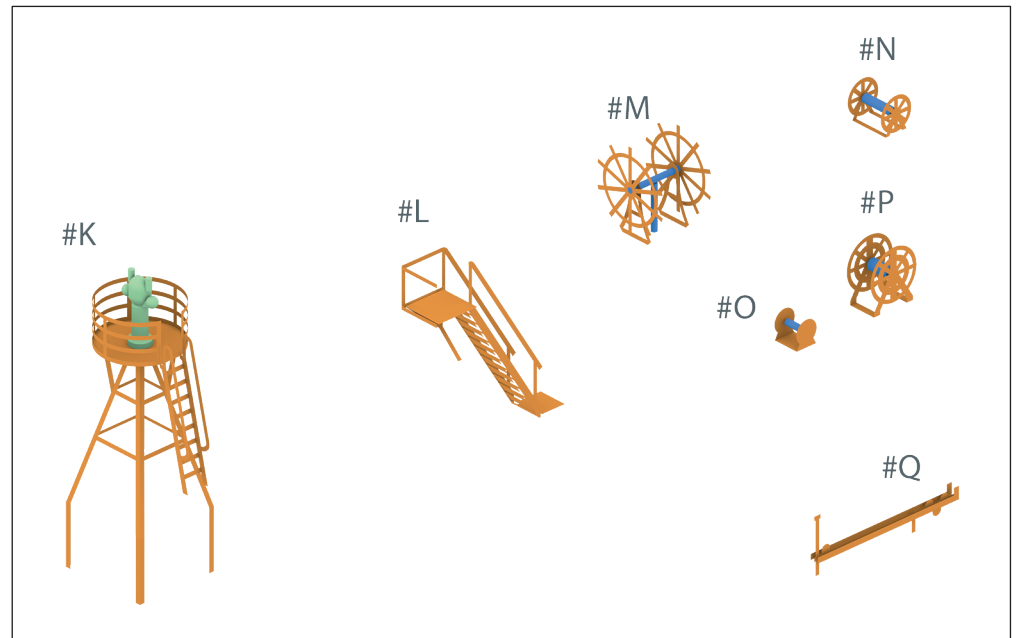
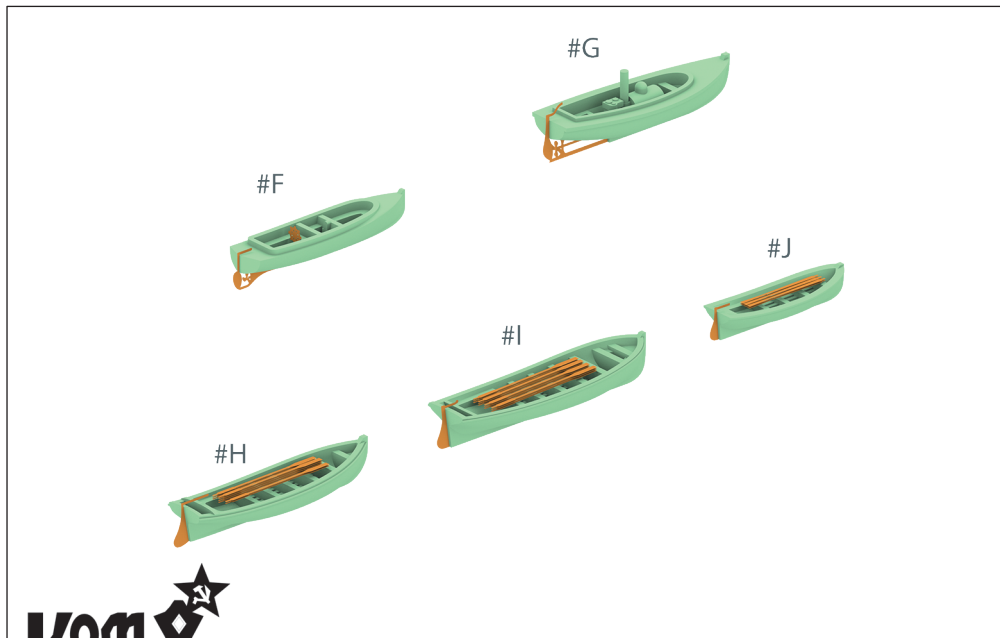
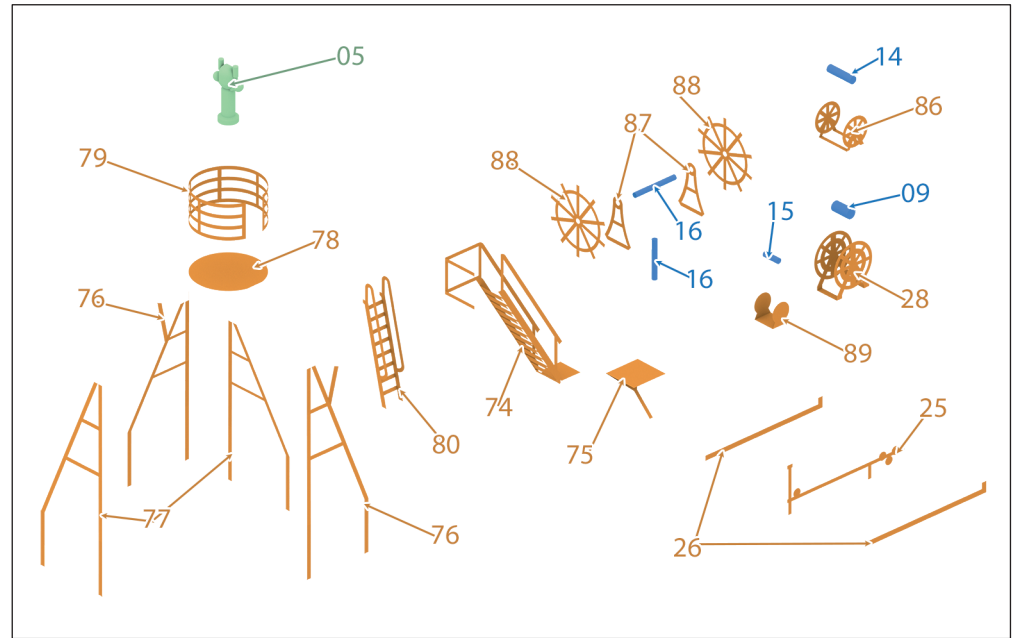
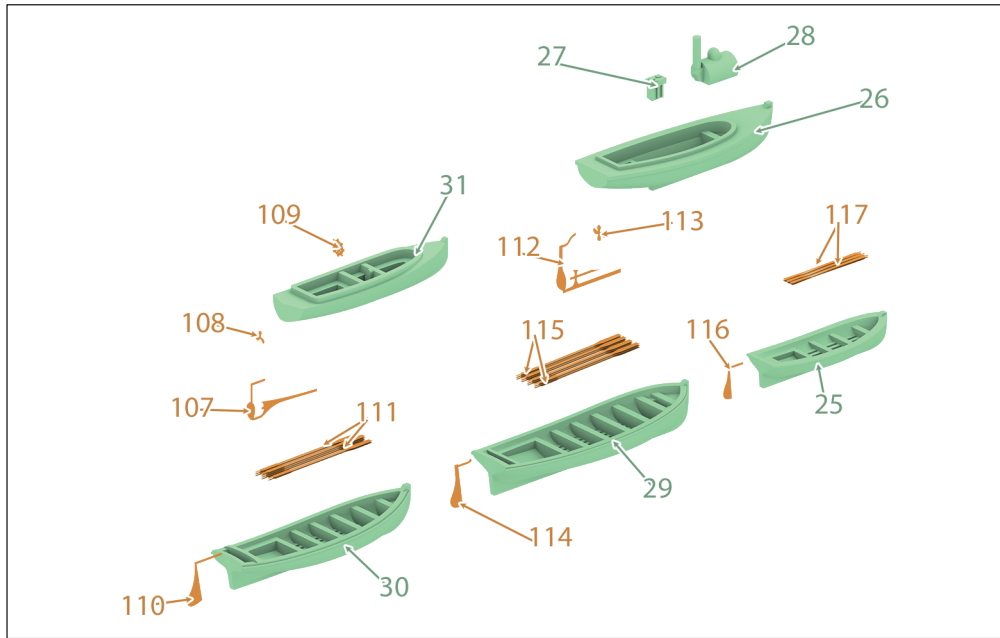

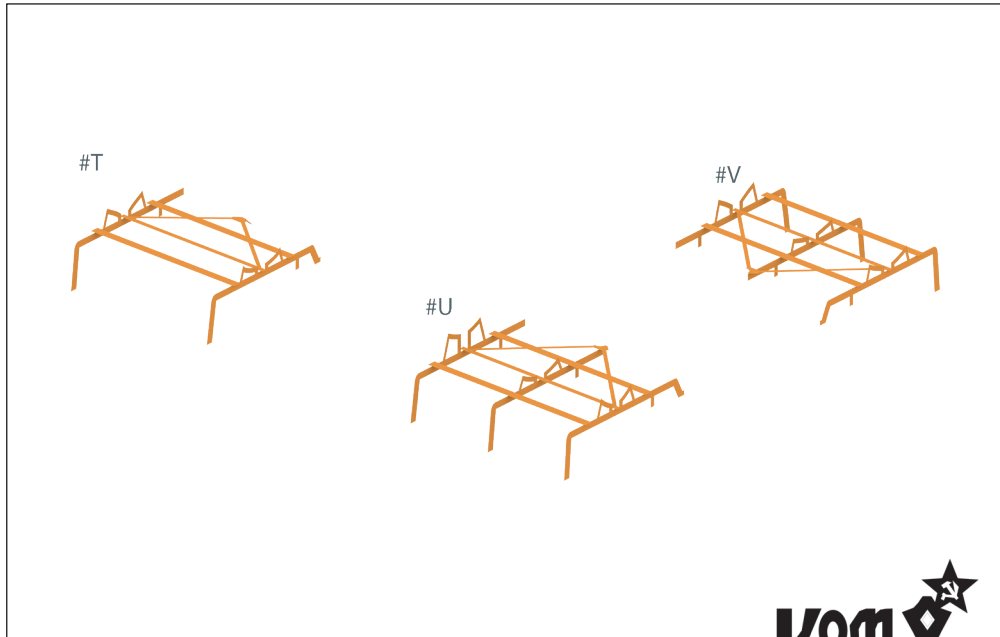
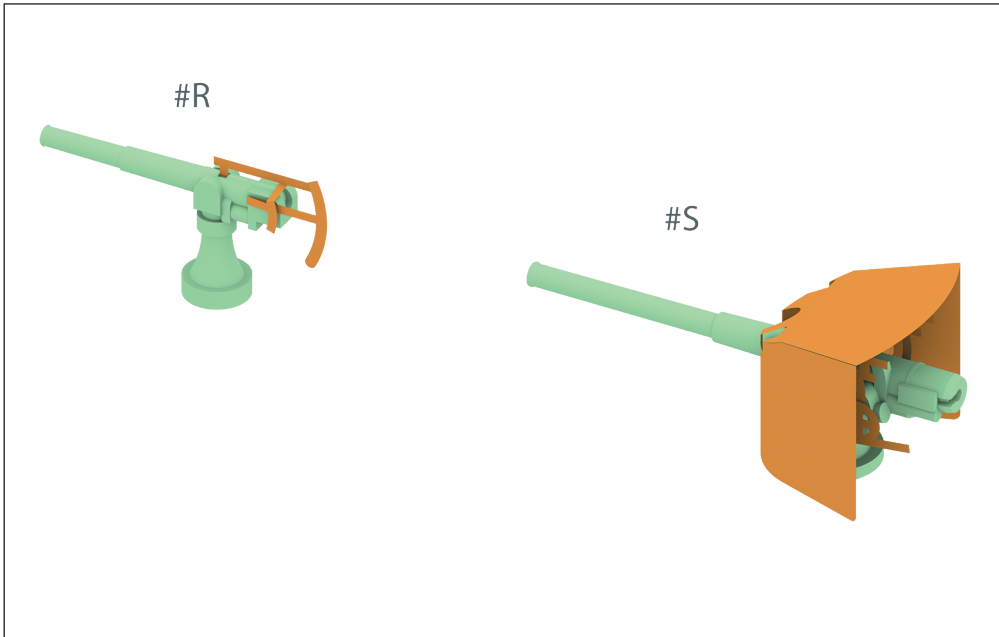
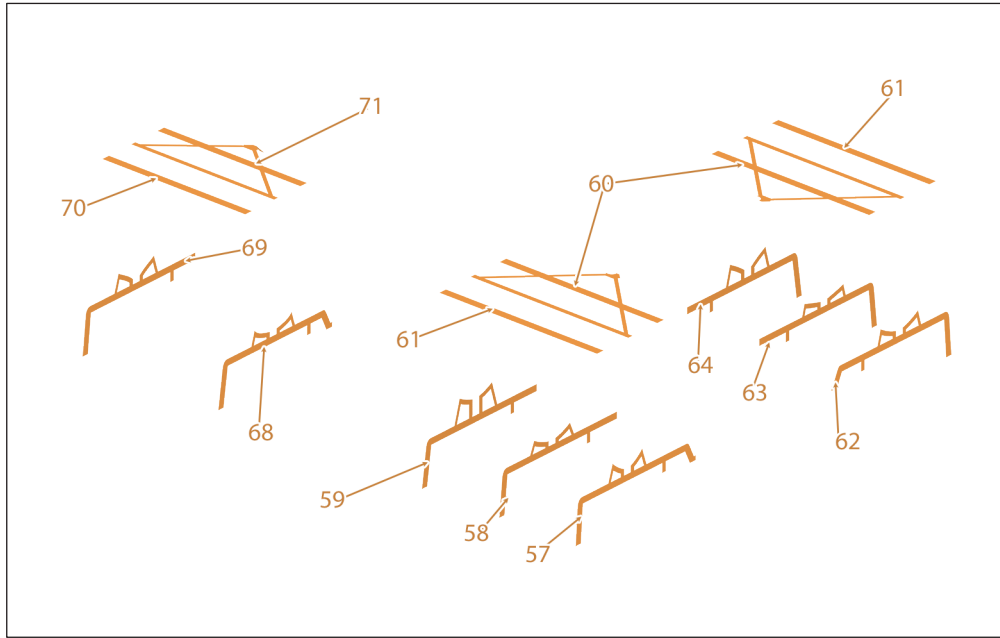
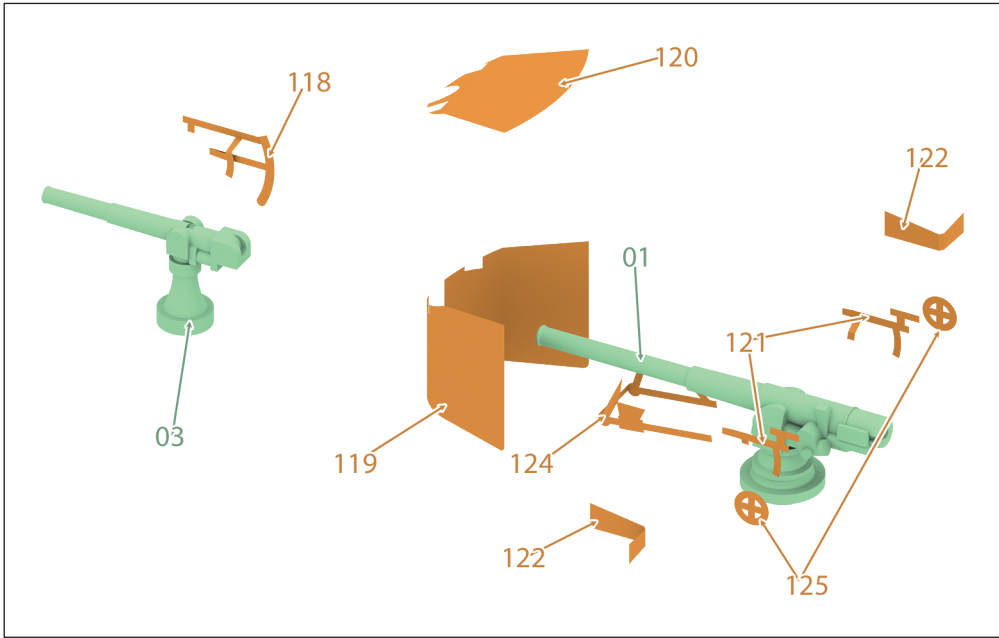

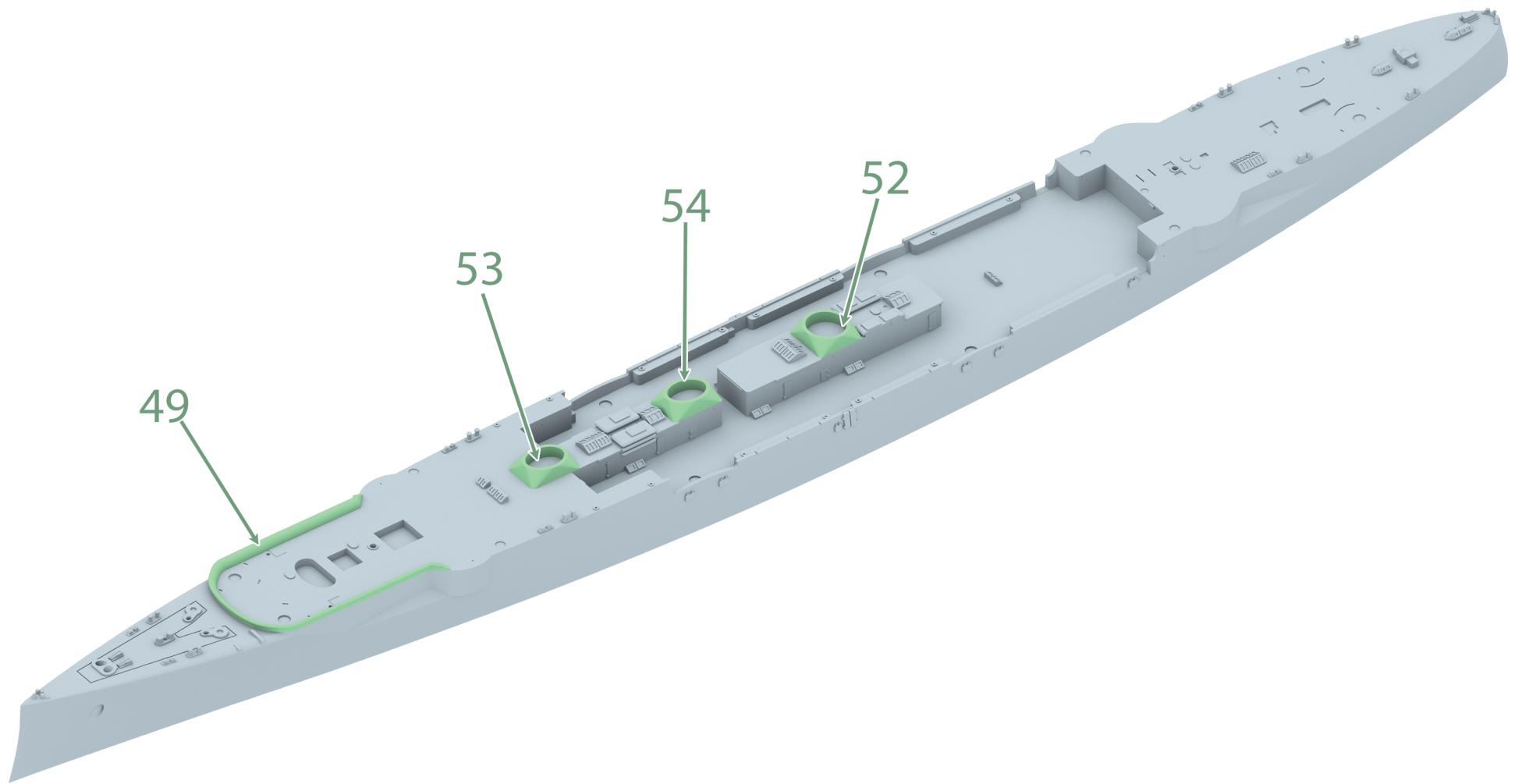

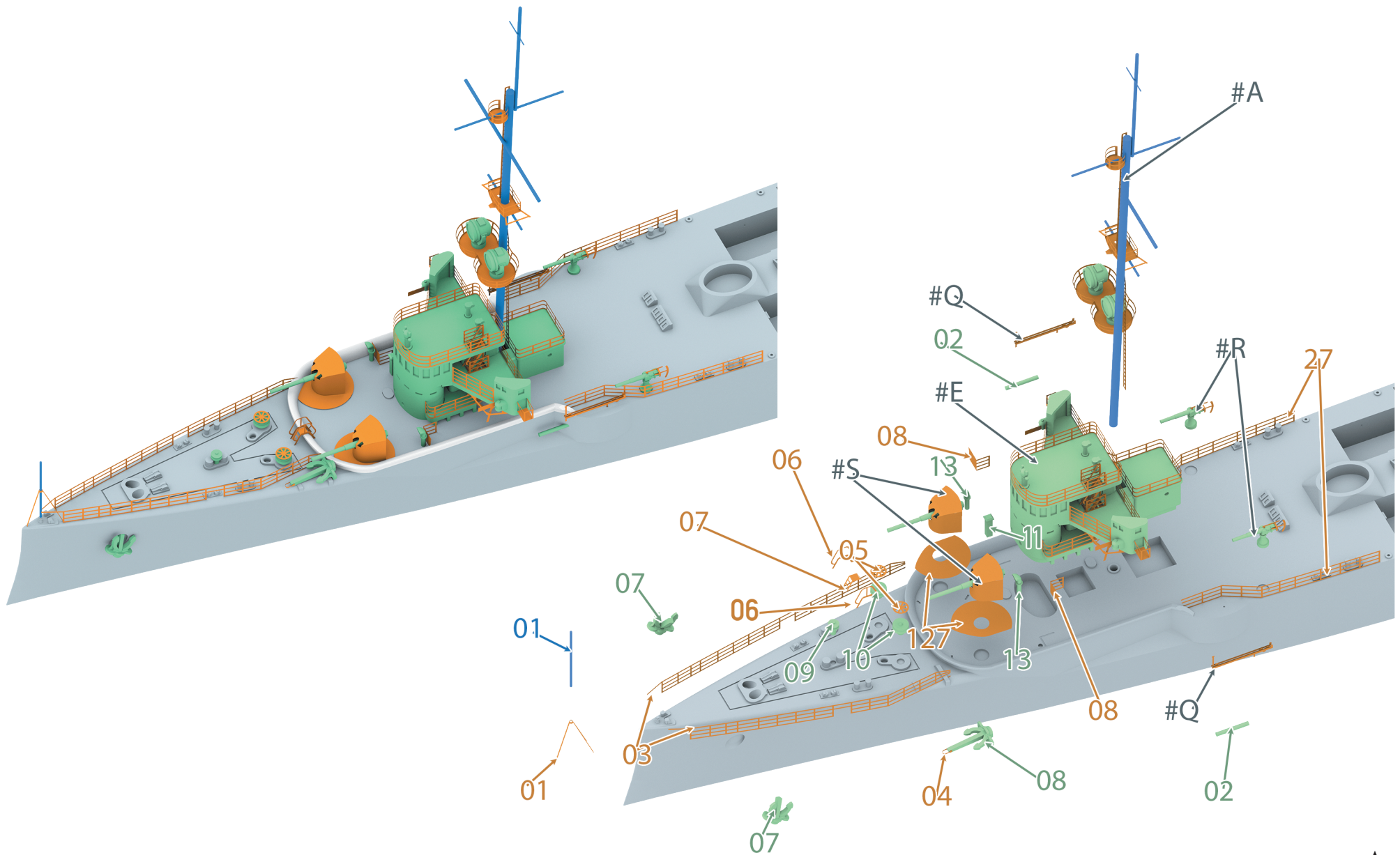

70529 For more info on Combrig kits see: www.combrig-models.com www.steelnavy.net www.modelwarships.com

1:700



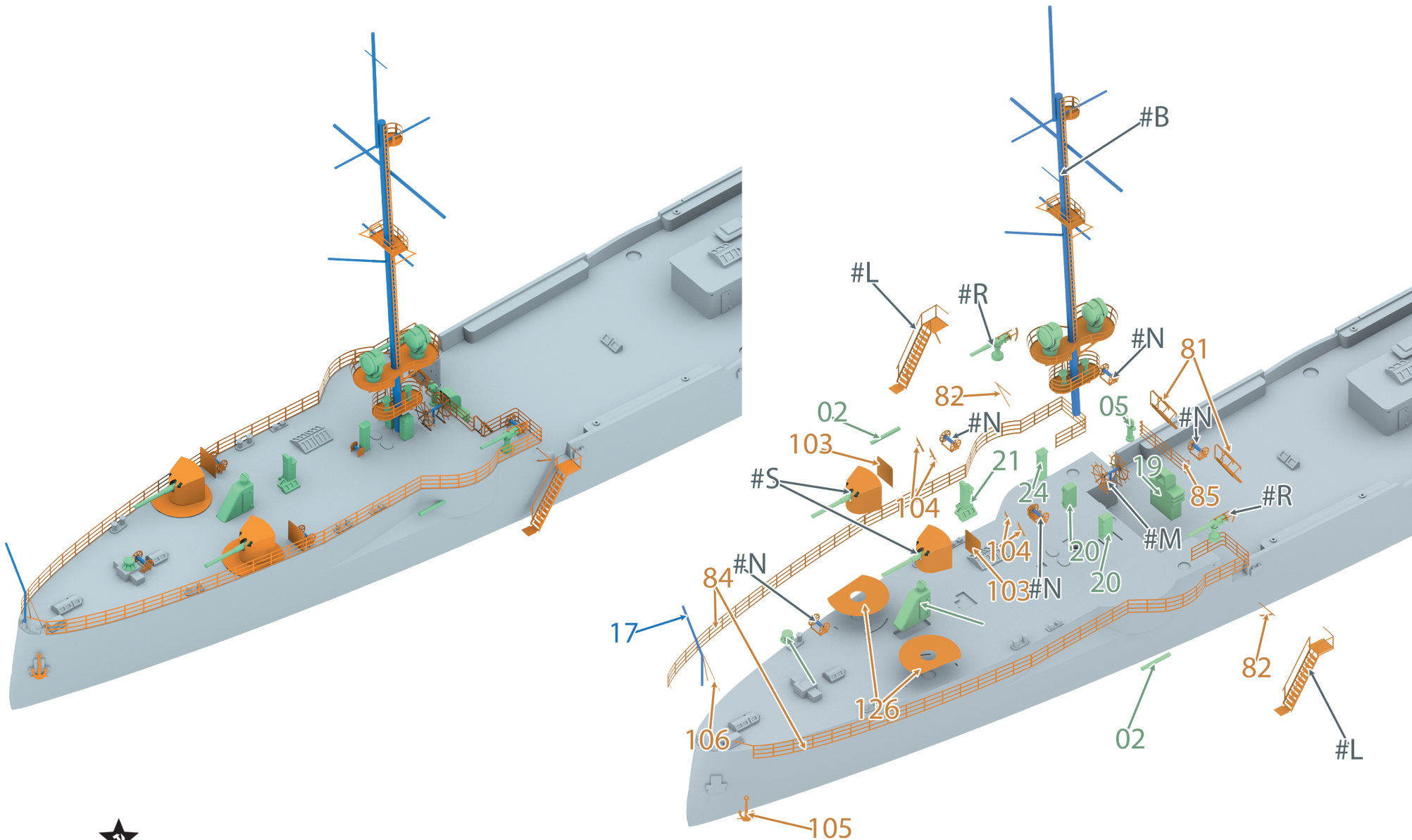

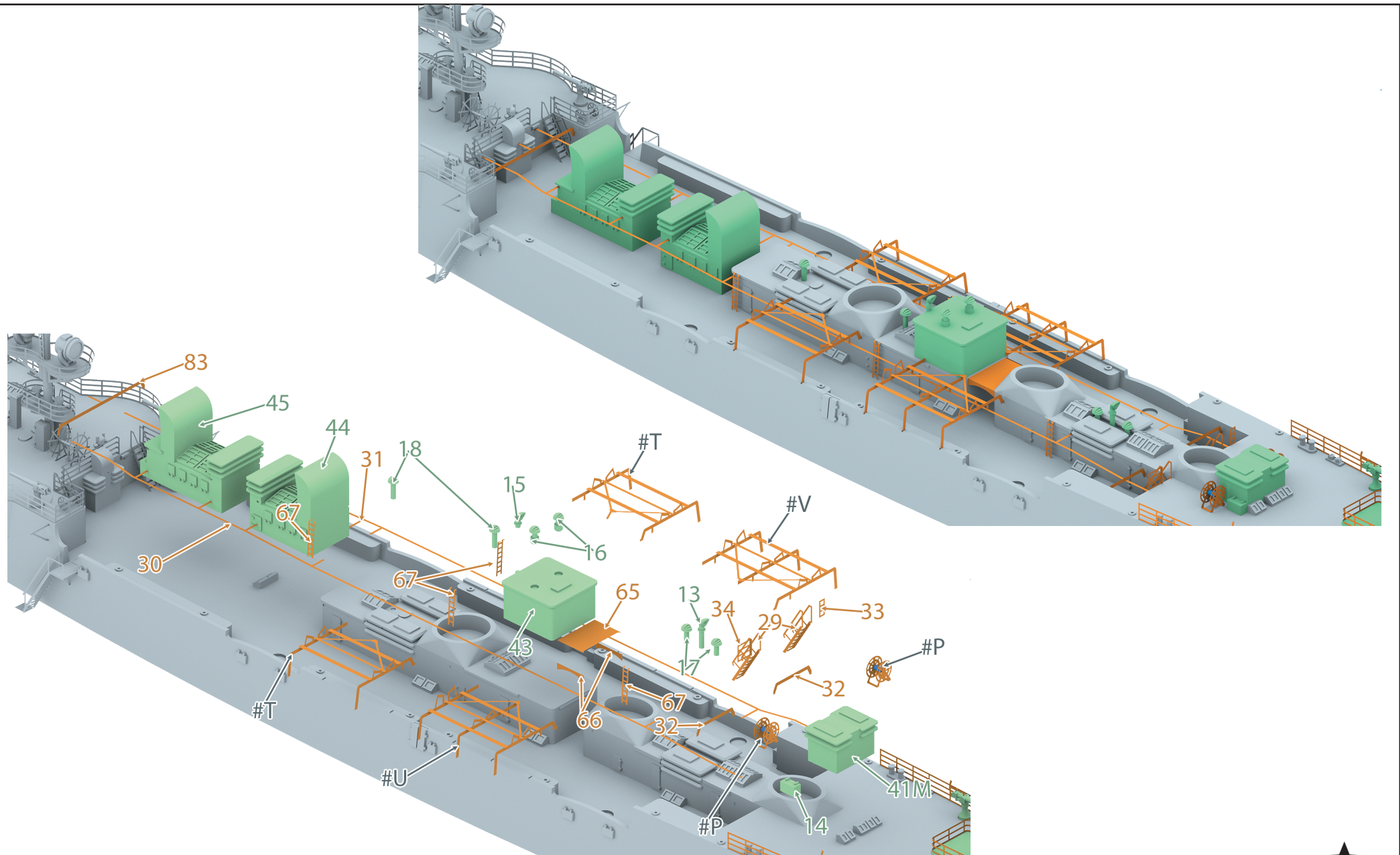

70529 For more info on Combrig kits see: www.combrig-models.com www.steelnavy.net www.modelwarships.com

1:700



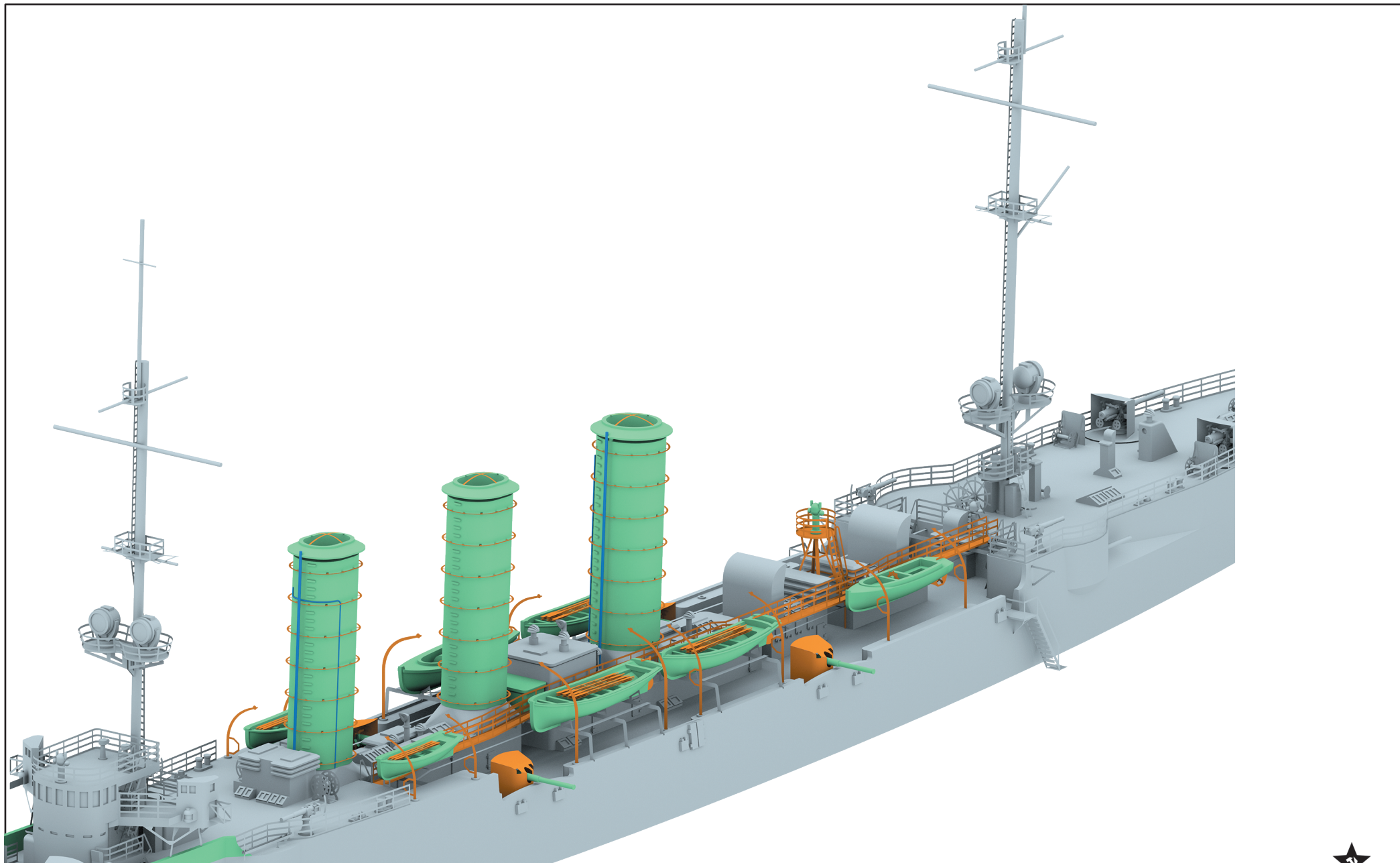

70529 For more info on Combrig kits see: www.combrig-models.com www.steelnavy.net www.modelwarships.com

1:700

**Ком
Бриг**
Made in Russia

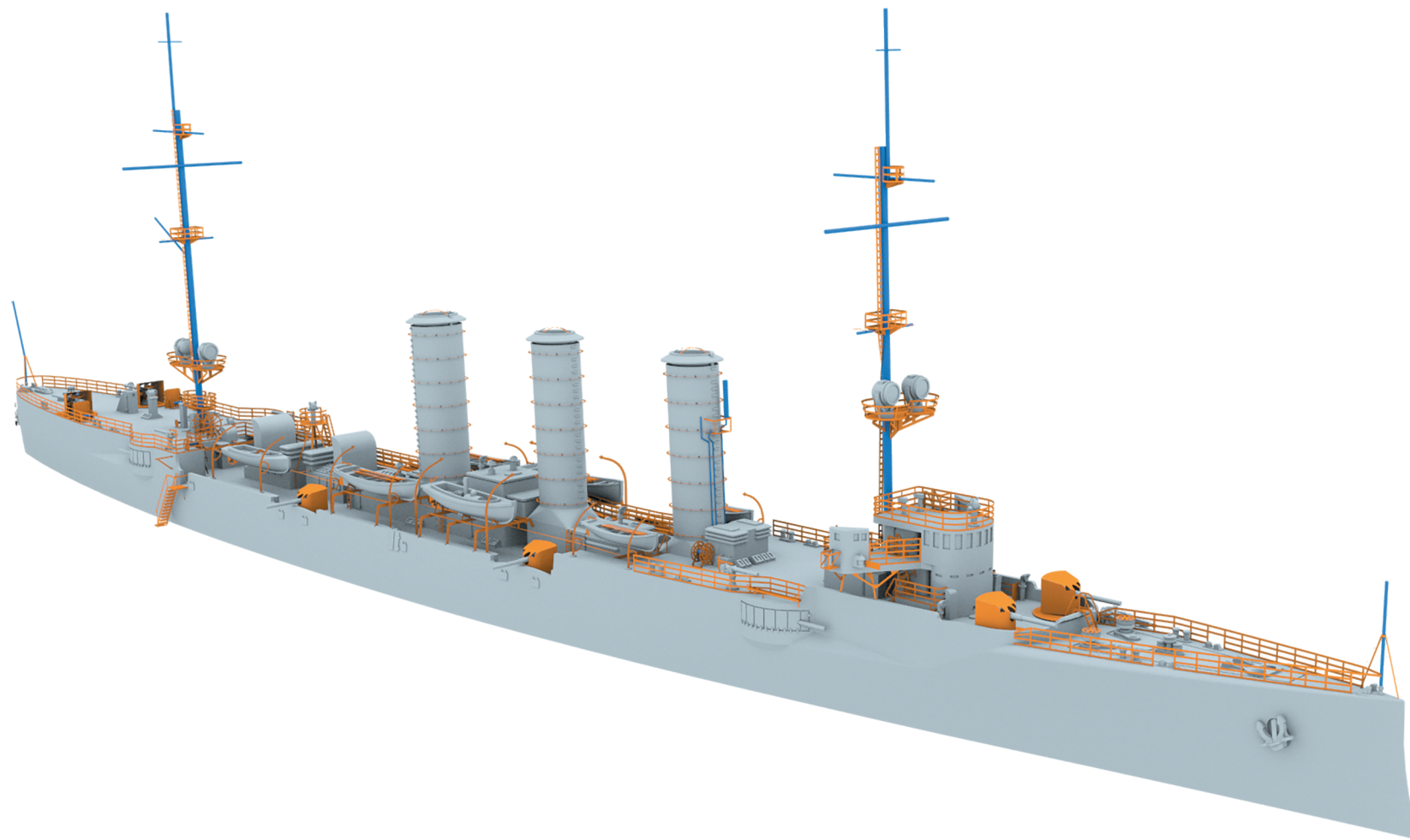

70529 For more info on Combrig kits see: www.combrig-models.com www.steelnavy.net www.modelwarships.com

1:700

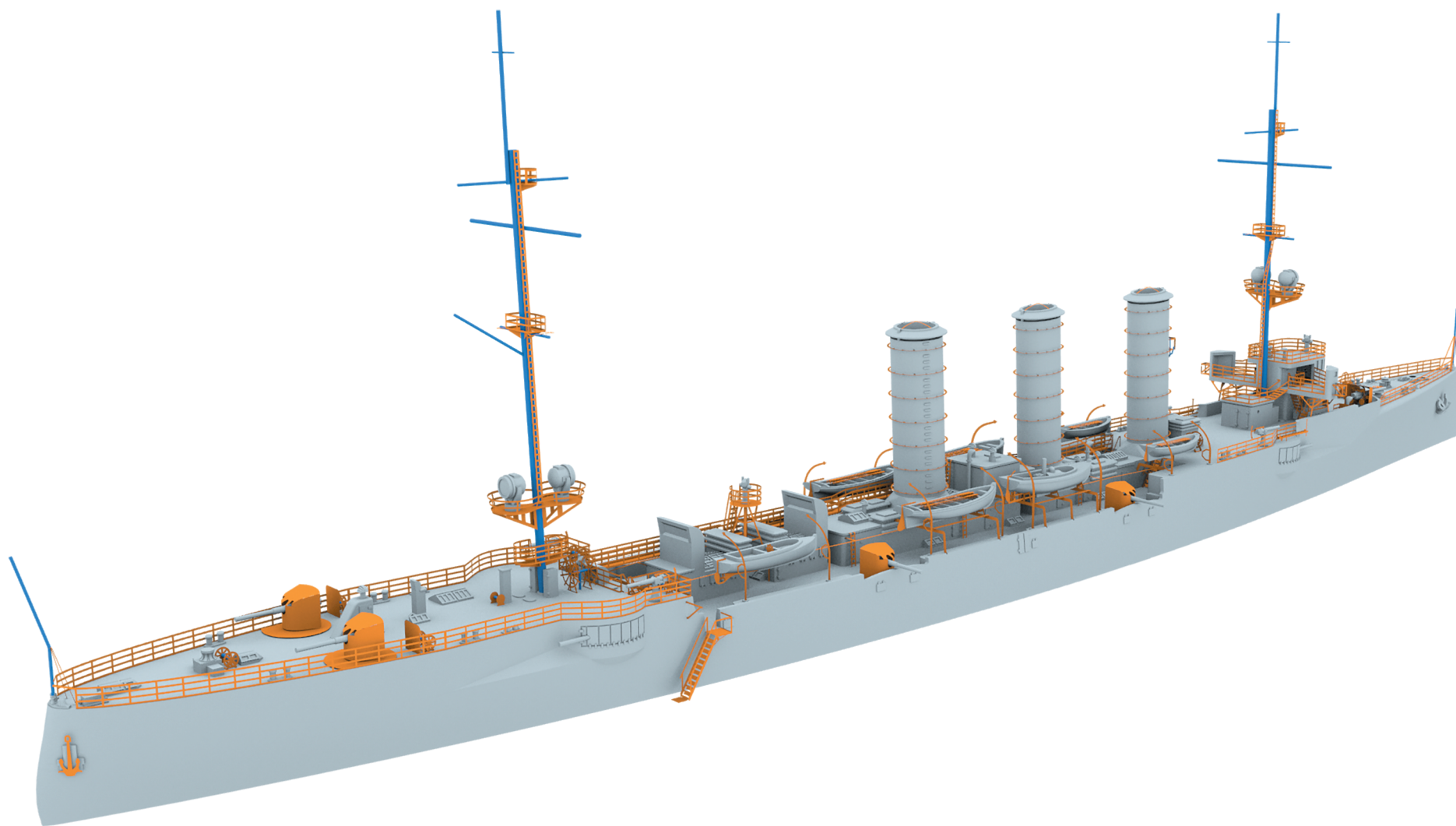

70529 For more info on Combrig kits see: www.combrig-models.com www.steelnavy.net www.modelwarships.com

1:700

