

Sampson-class destroyer 1916

USS Wilkes (DD-67)

1/700

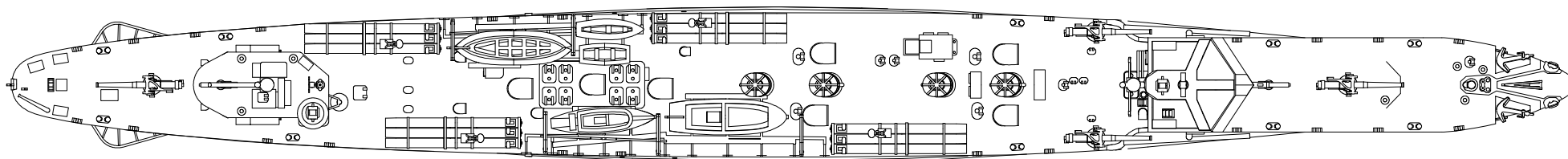

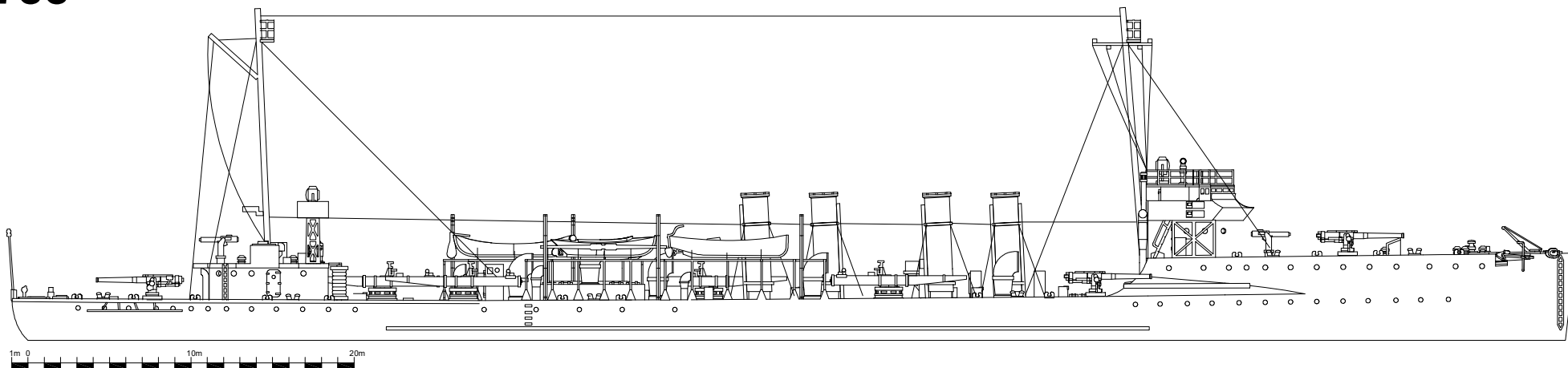
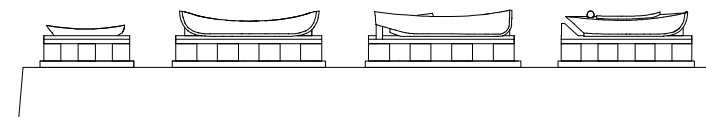
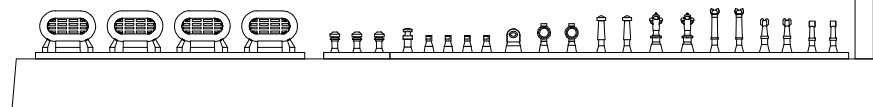
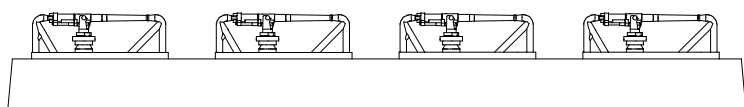
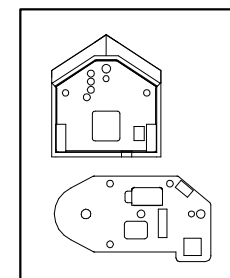
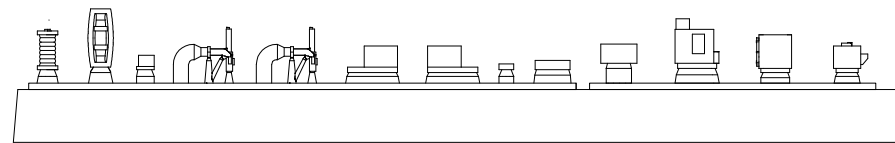
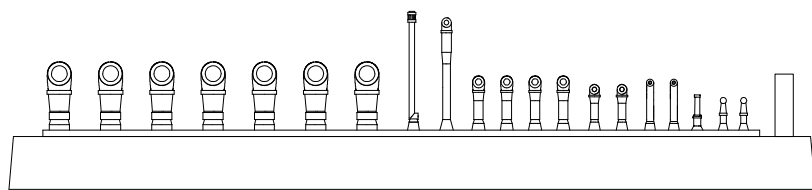
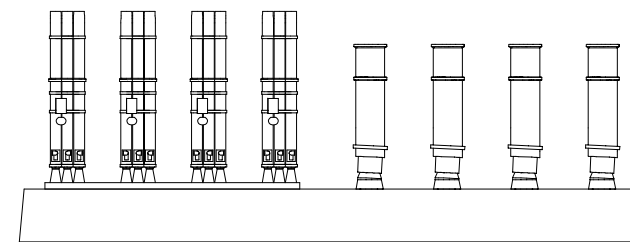
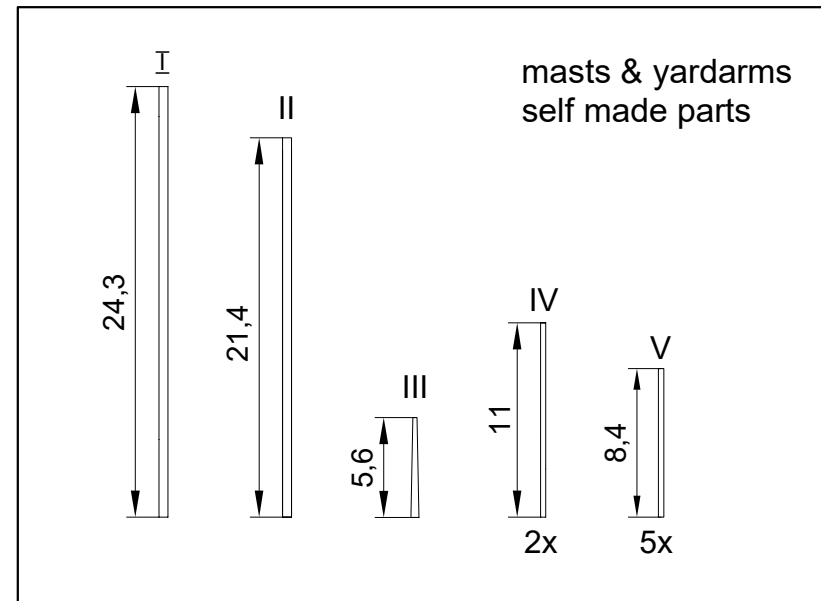
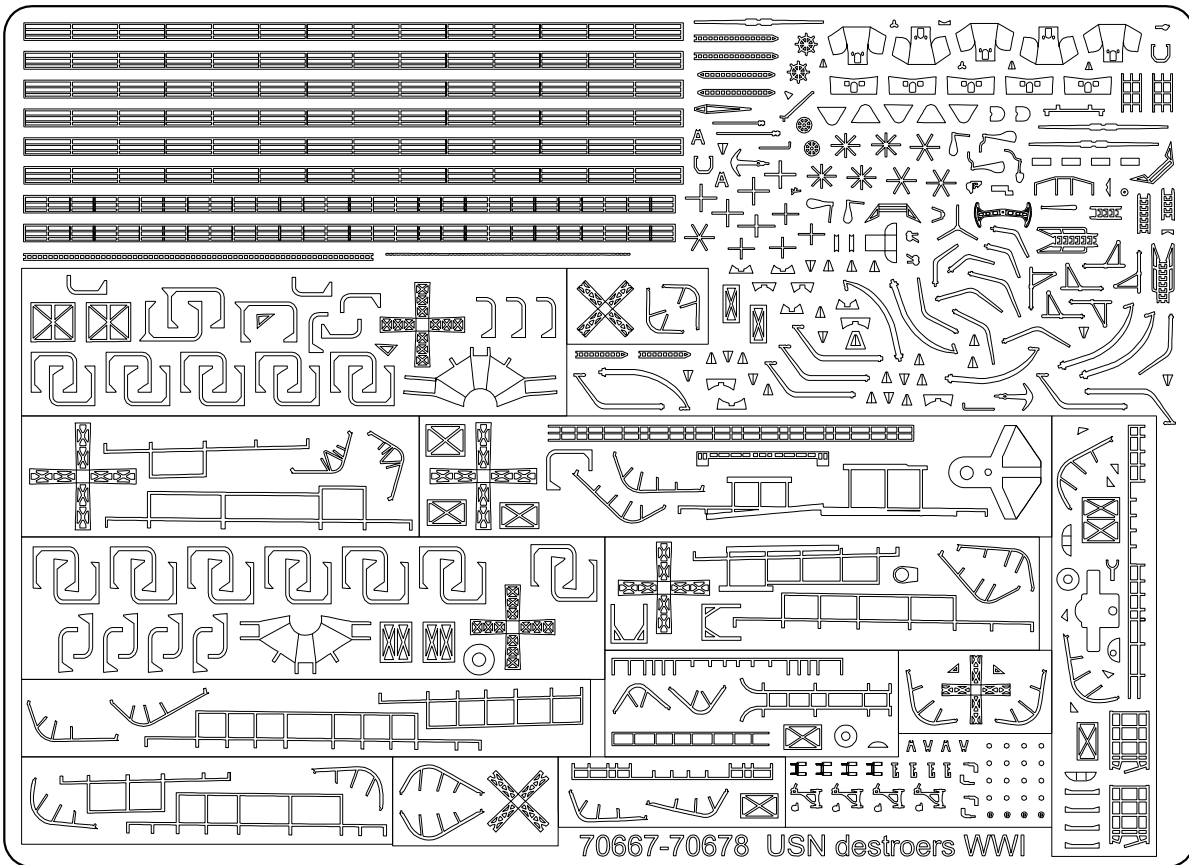

Please note that the assembly guide reflects the position of the parts when installed only, and not the exact order of the assembly.

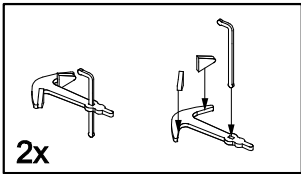

2x

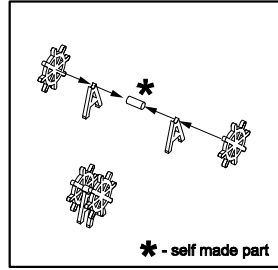
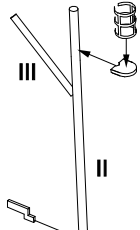

* - self made part

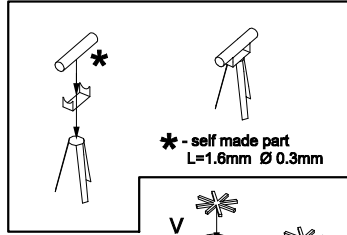

* - self made part
L=1.6mm Ø 0.3mm

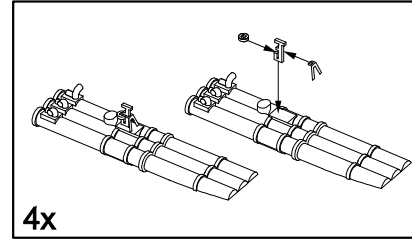

4x

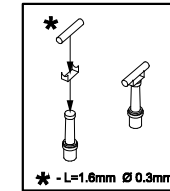
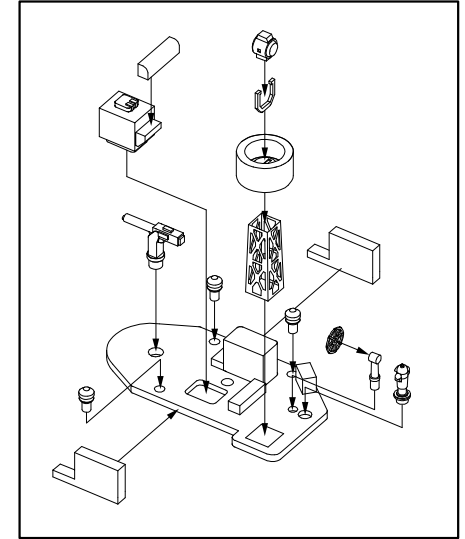

* - L=1.6mm Ø 0.3mm

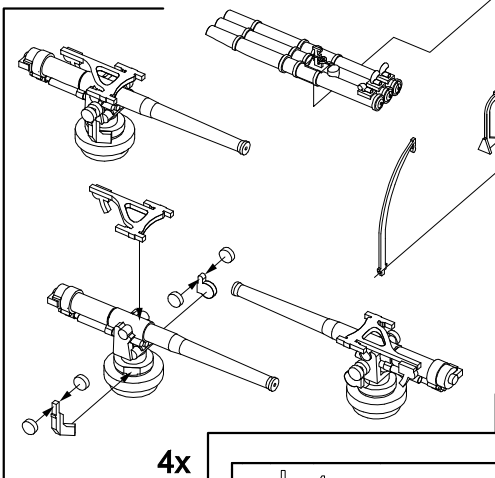
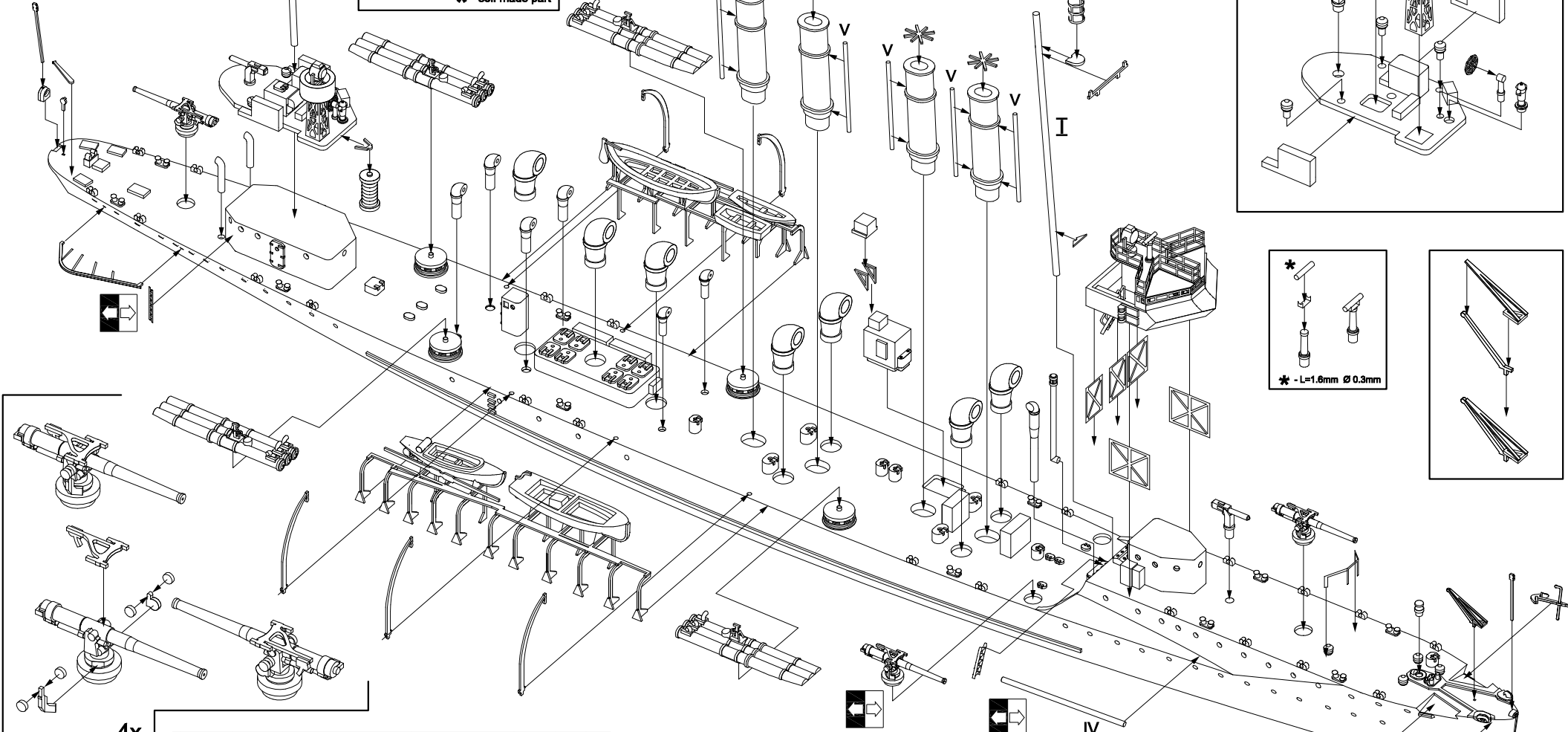
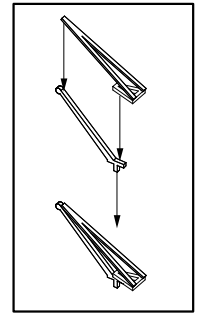

4x

