

British ocean liner, 1936

RMS Queen Mary

1/700

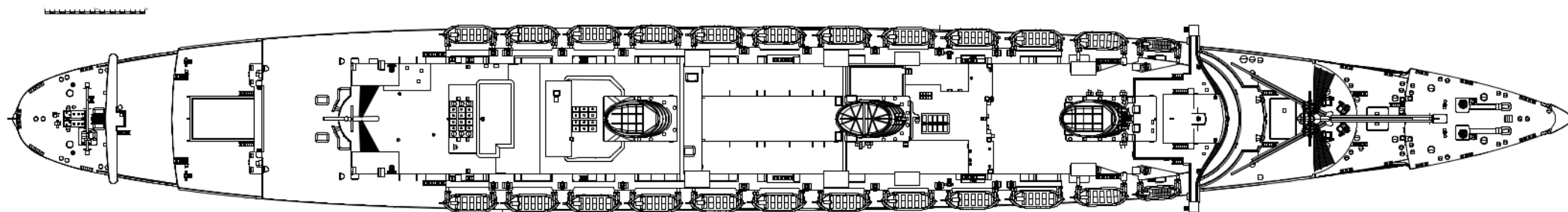

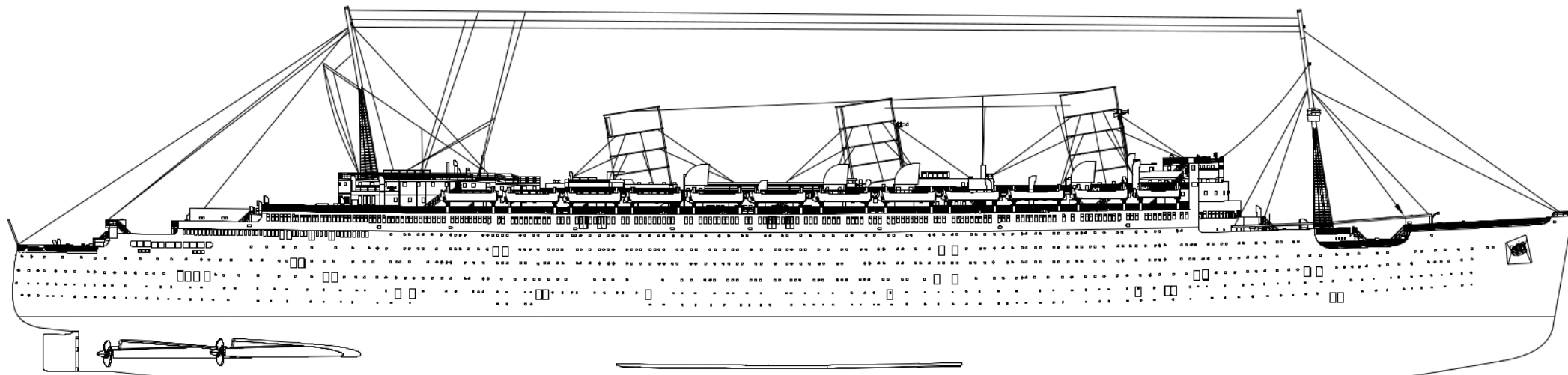
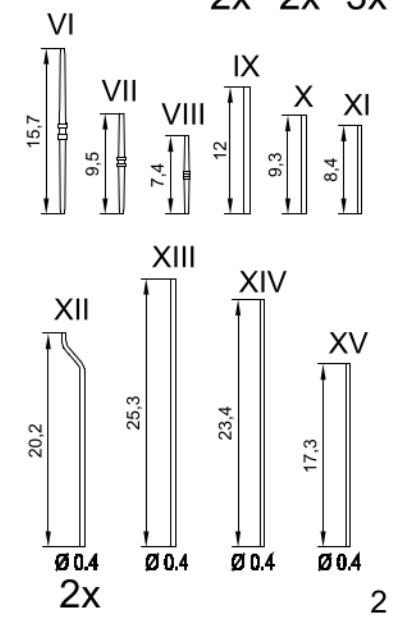
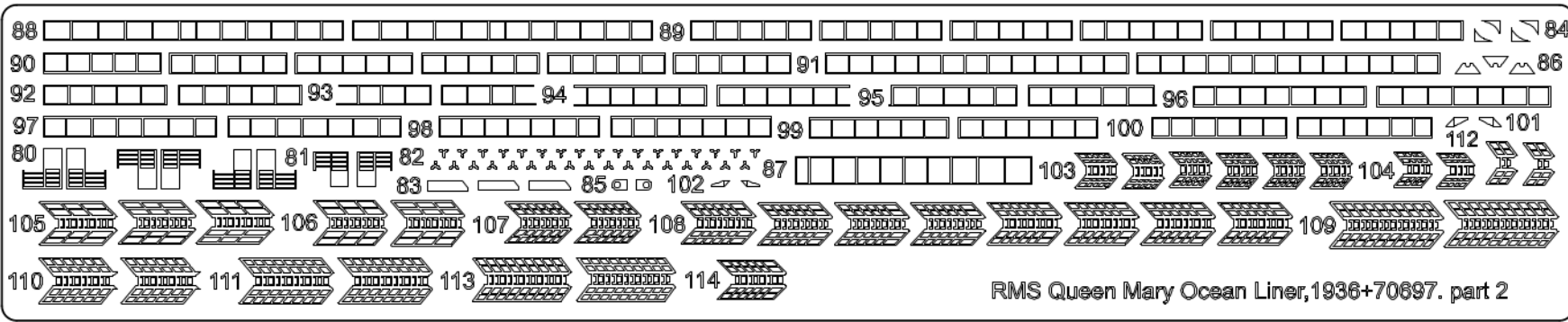
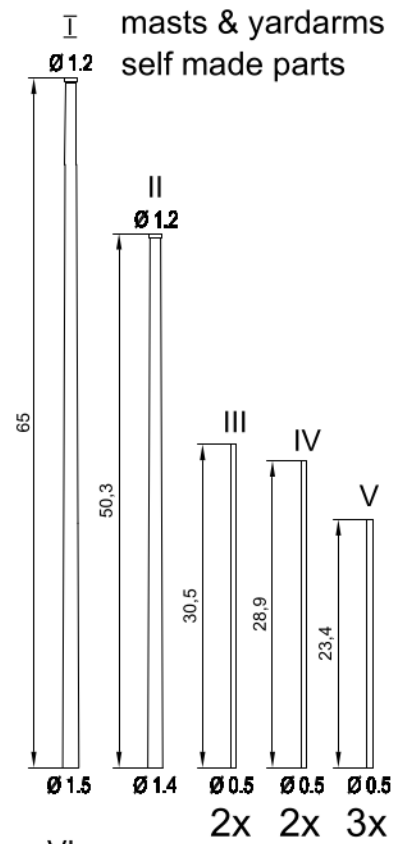
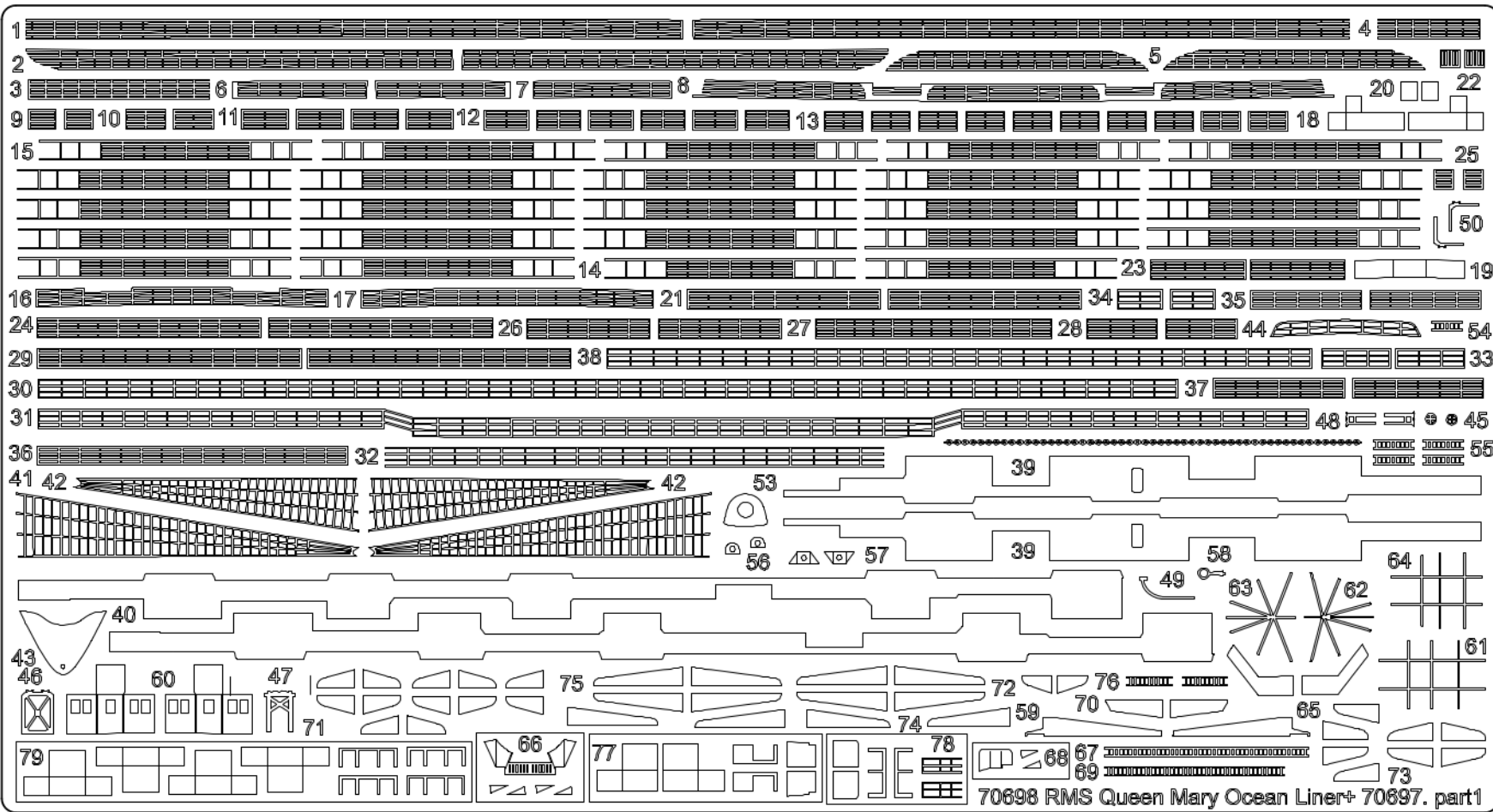

⚠ Please note that the assembly guide reflects the position of the parts when installed only, and not the exact order of the assembly.
To download the assembly instructions in PDF (high resolution) please visit www.combrig-models.com

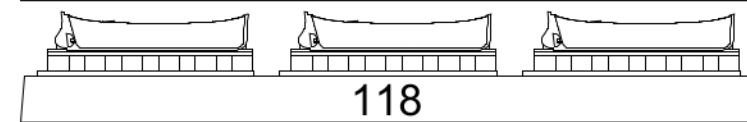
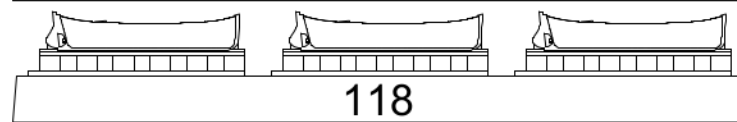
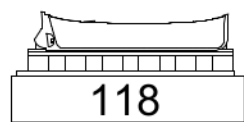
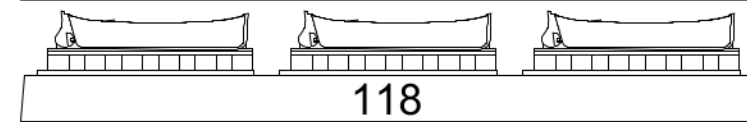
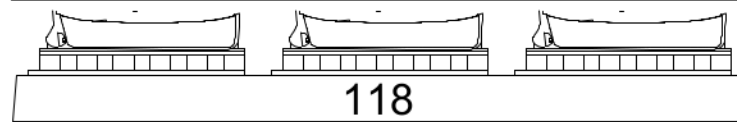
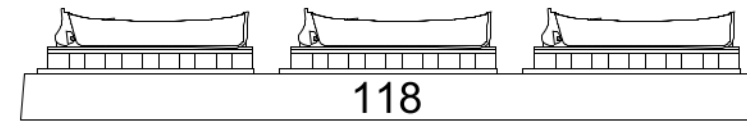
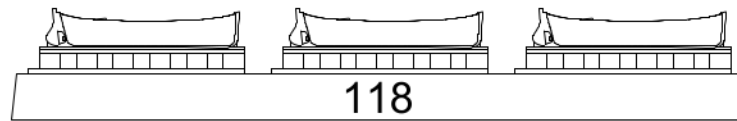
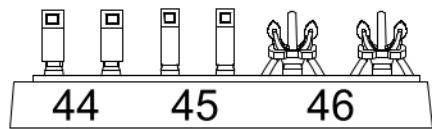
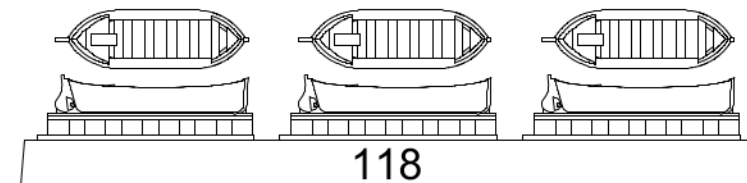
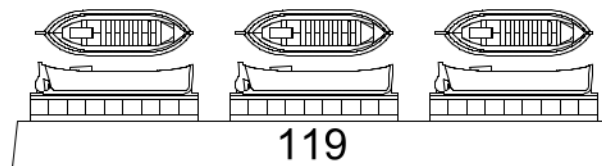
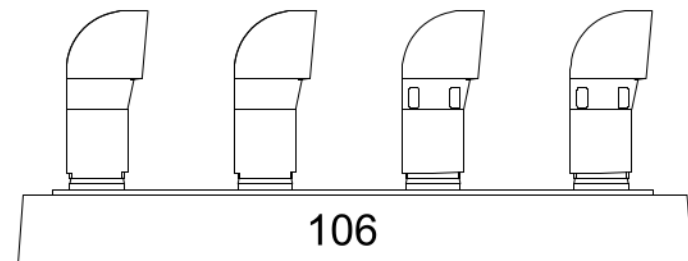
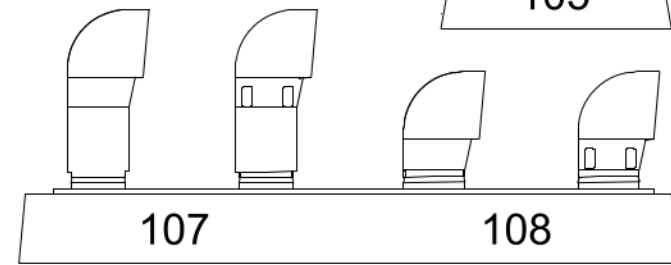
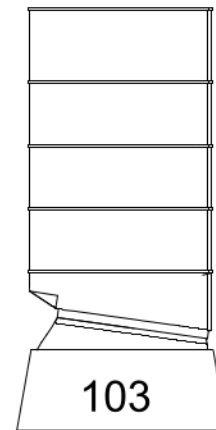
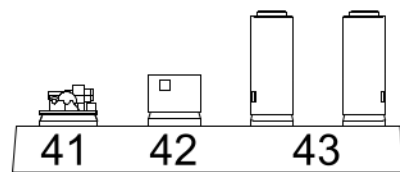
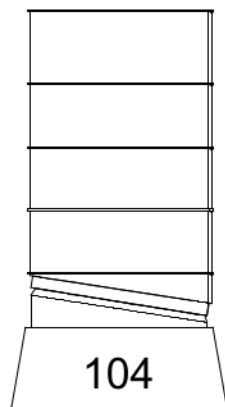
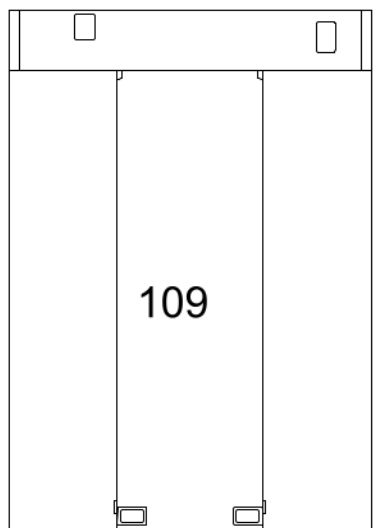
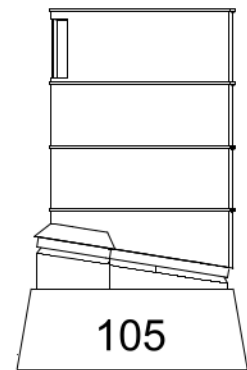
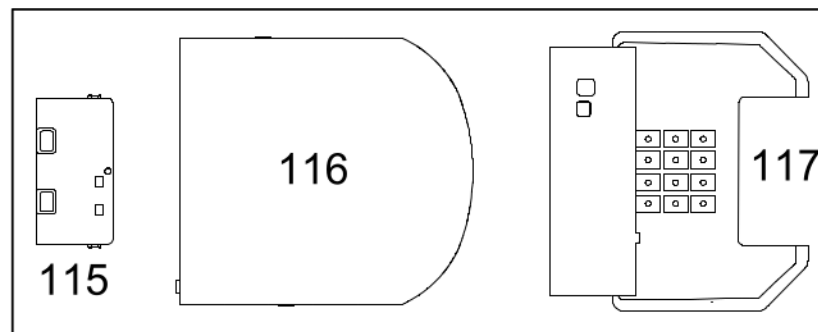
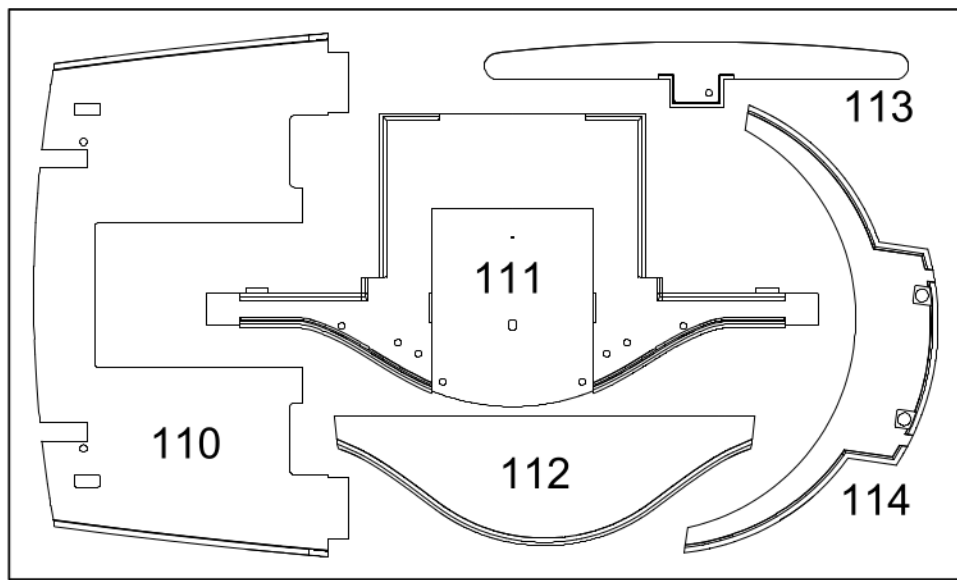

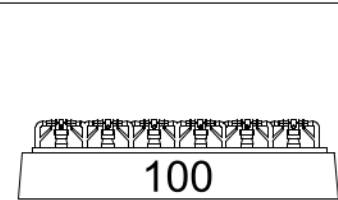
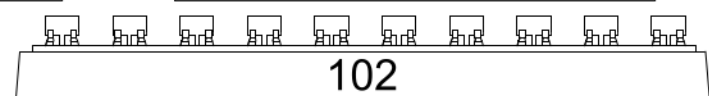
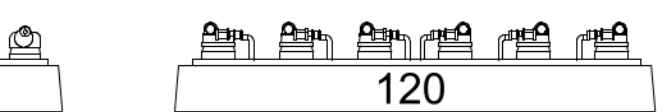
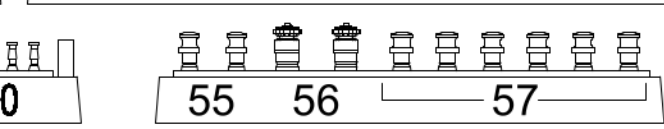
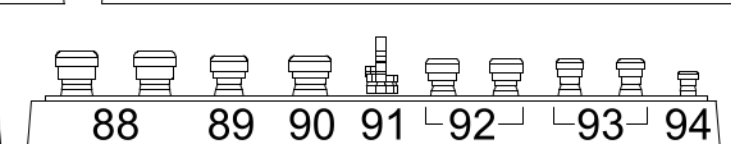
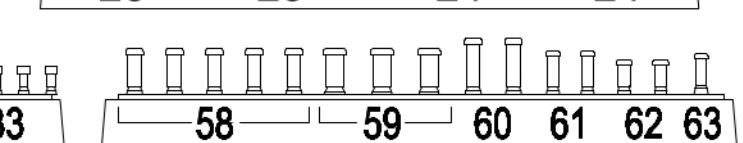
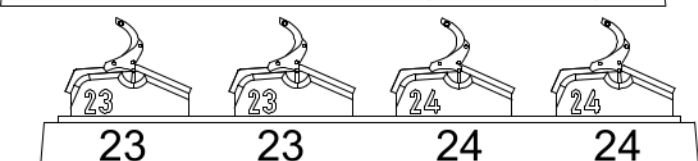
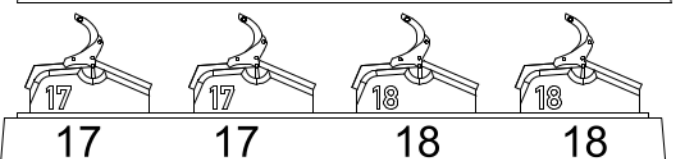
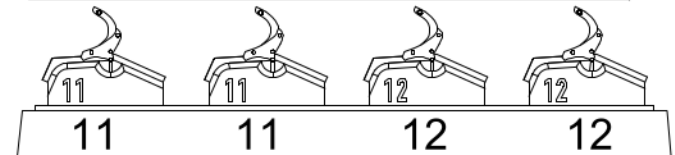
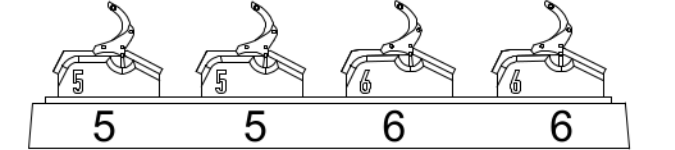
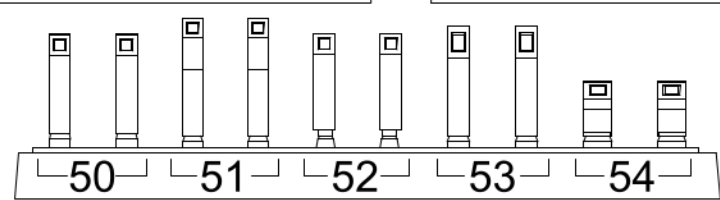
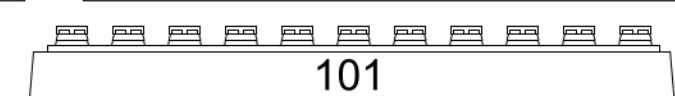
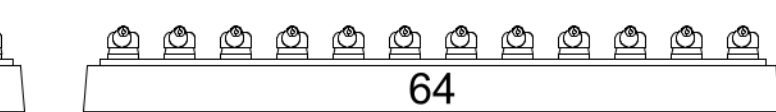
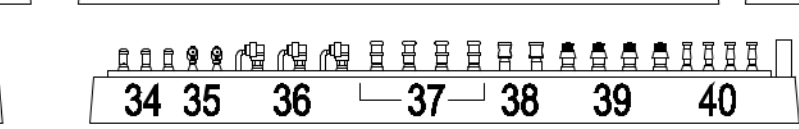
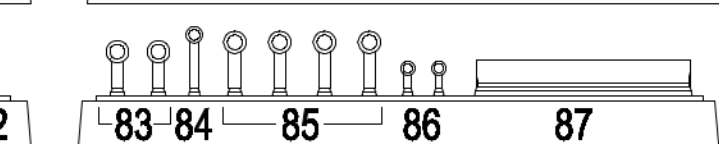
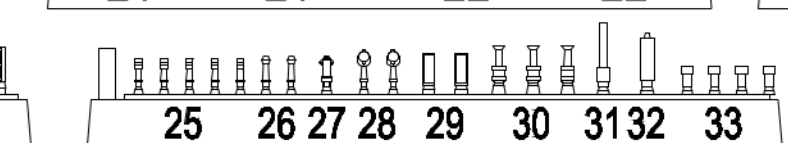
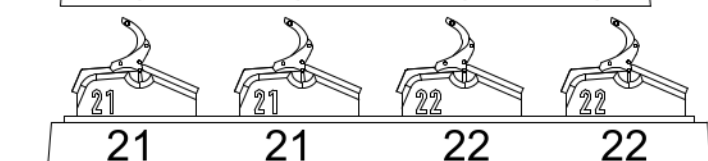
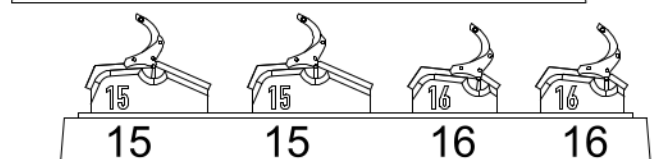
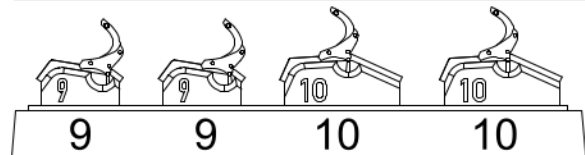
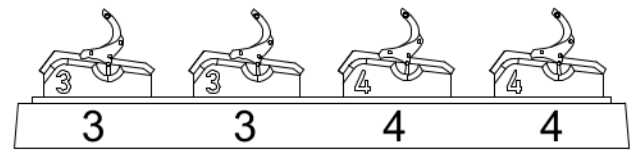
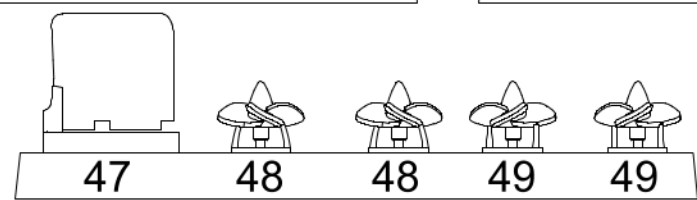
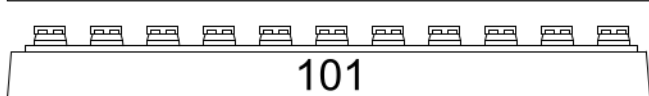
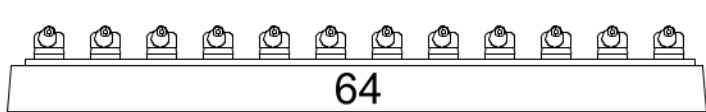
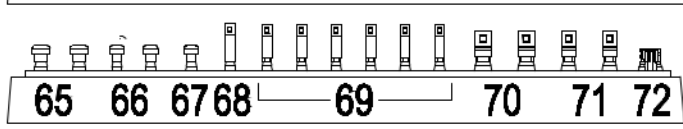
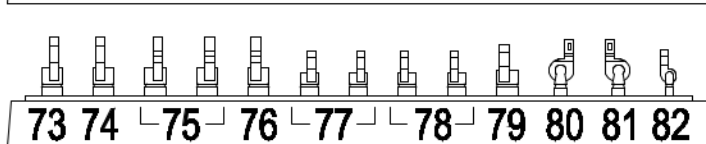
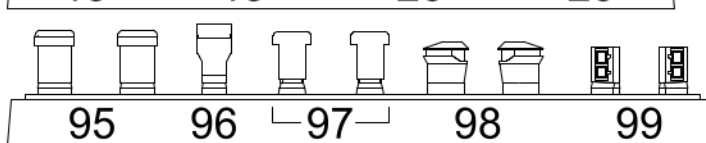
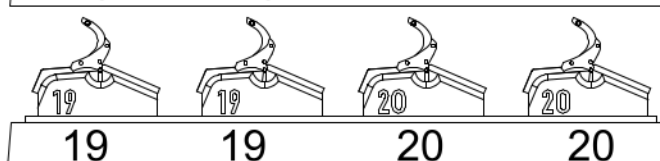
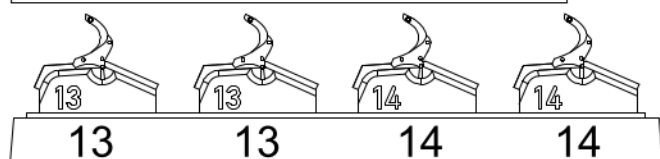
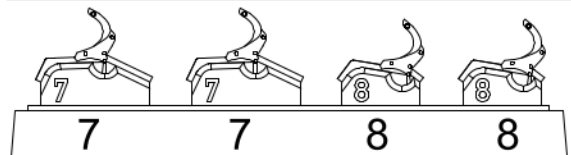
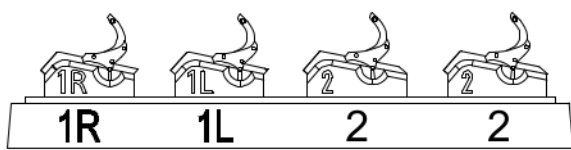

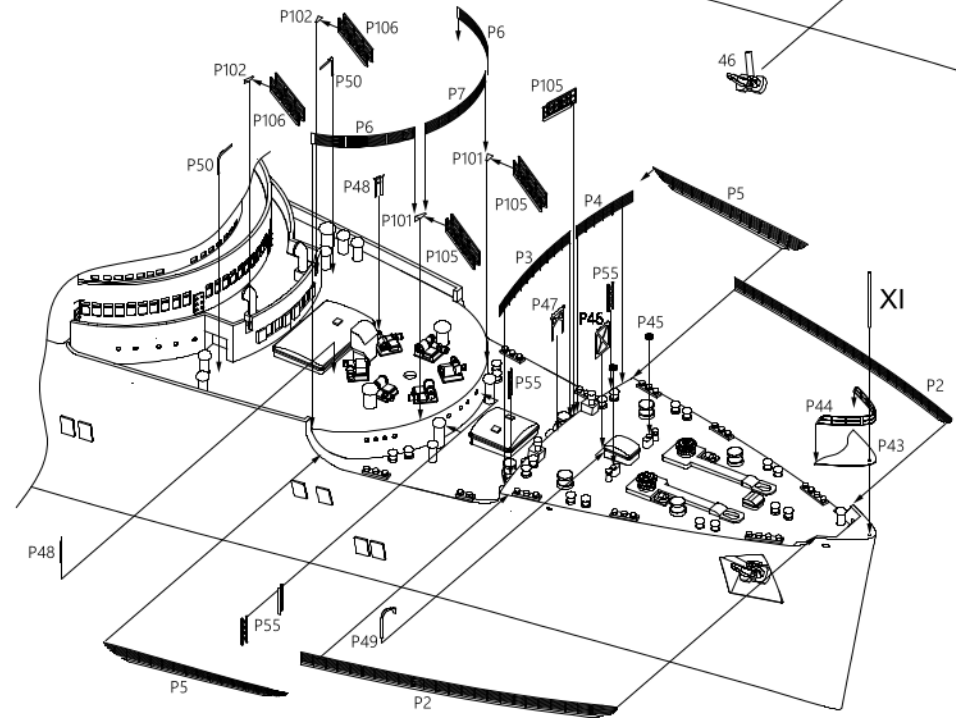
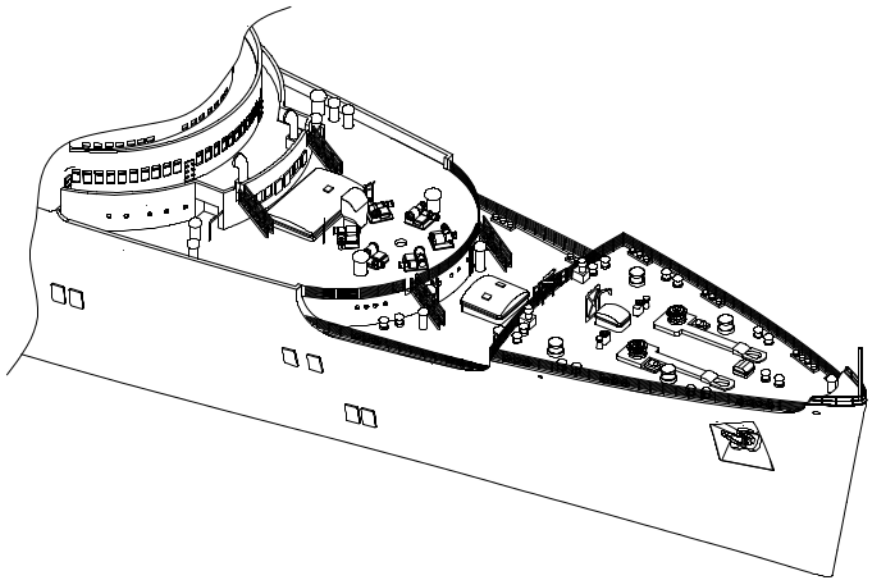
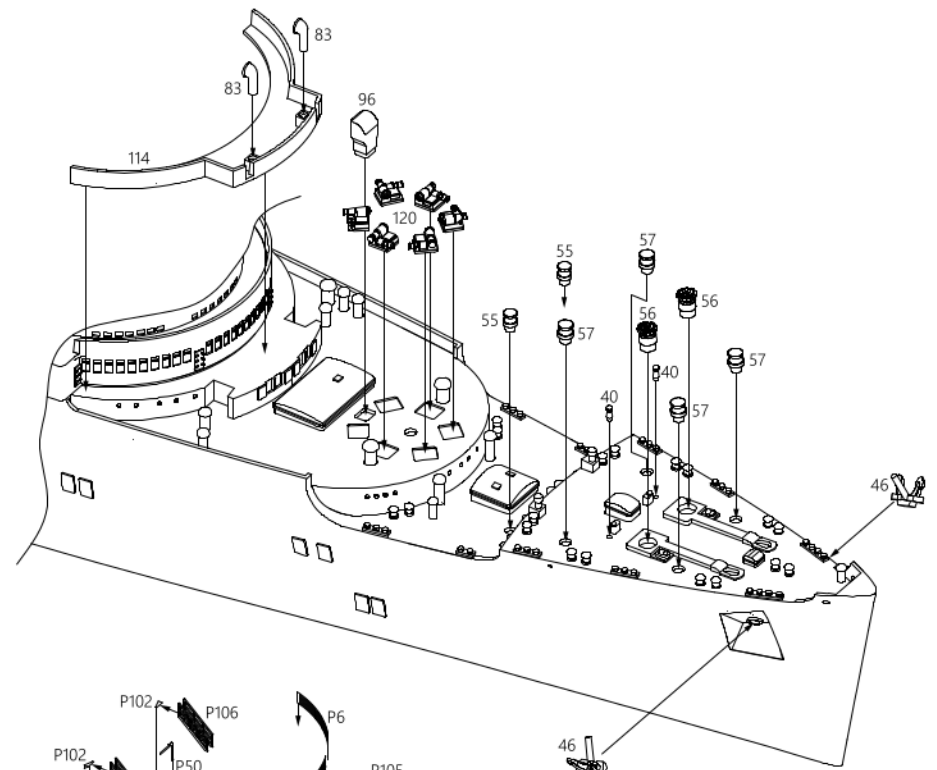
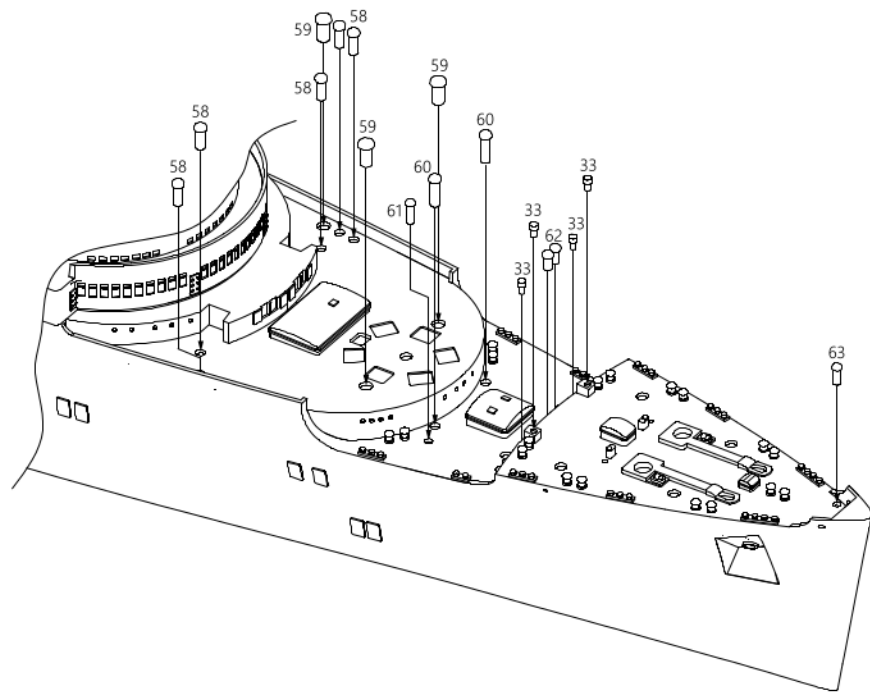

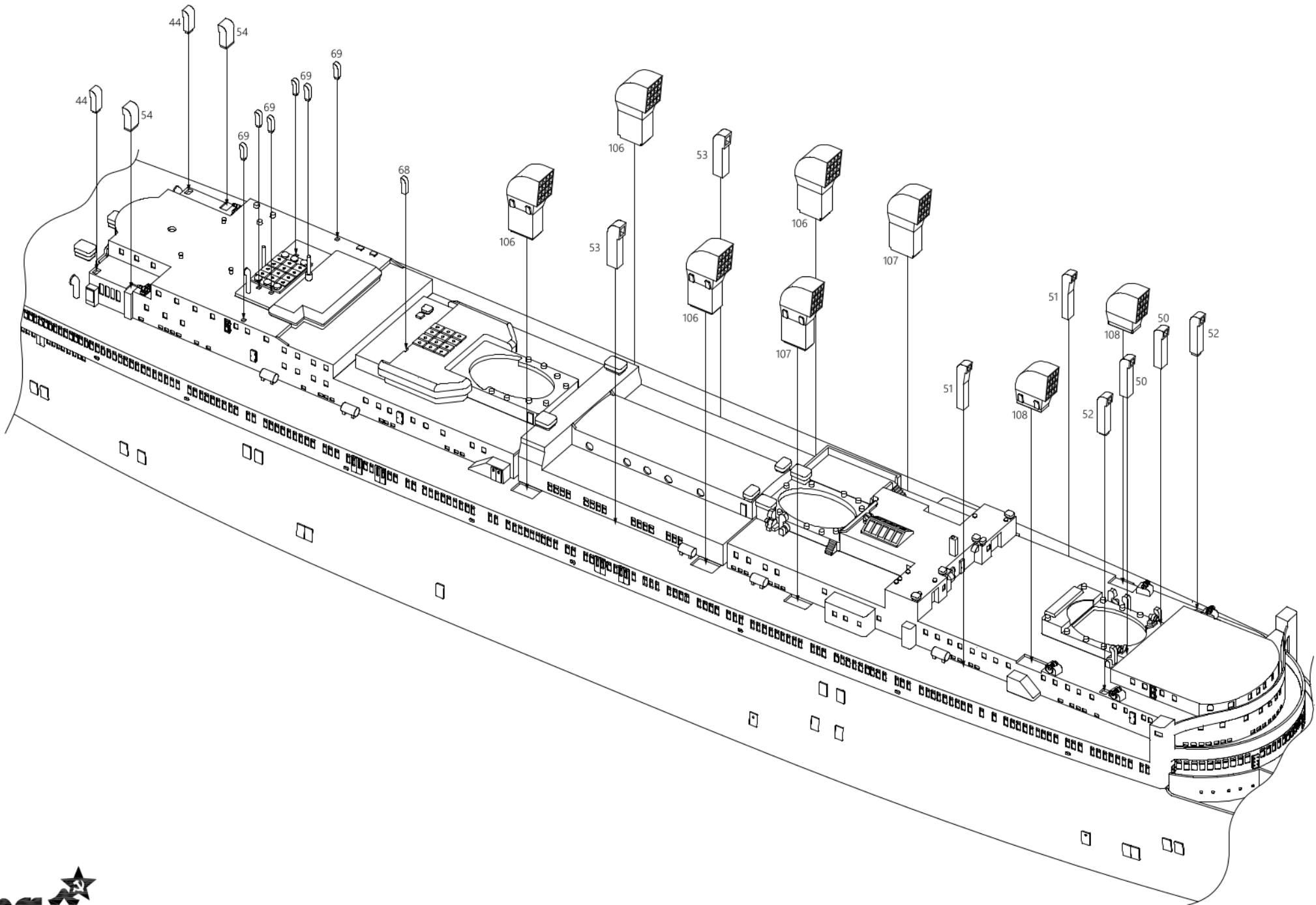

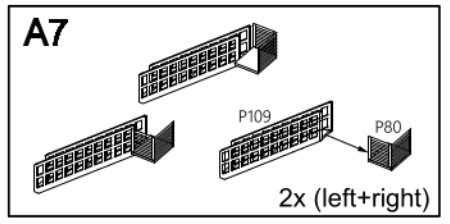
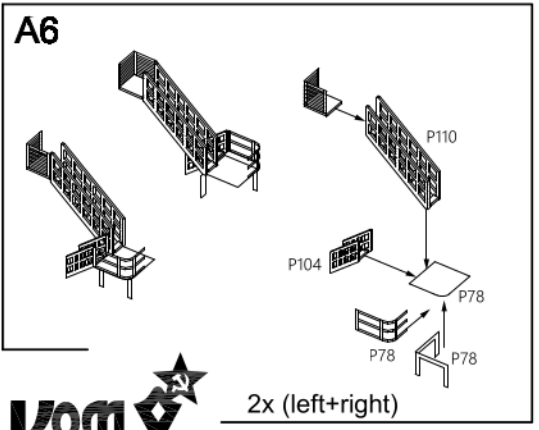
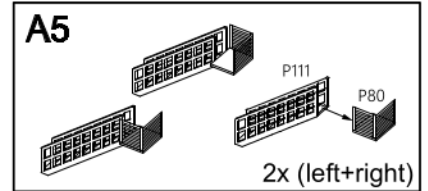
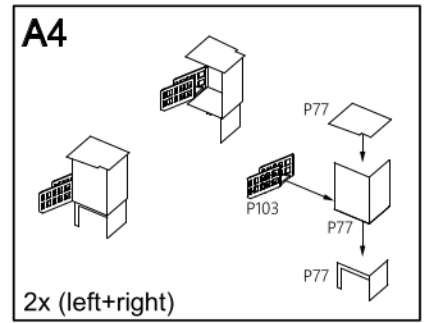
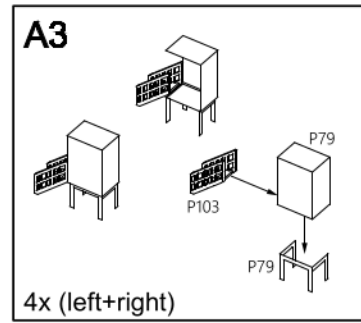
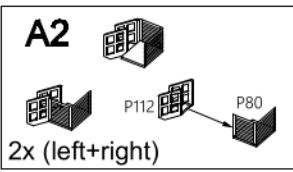
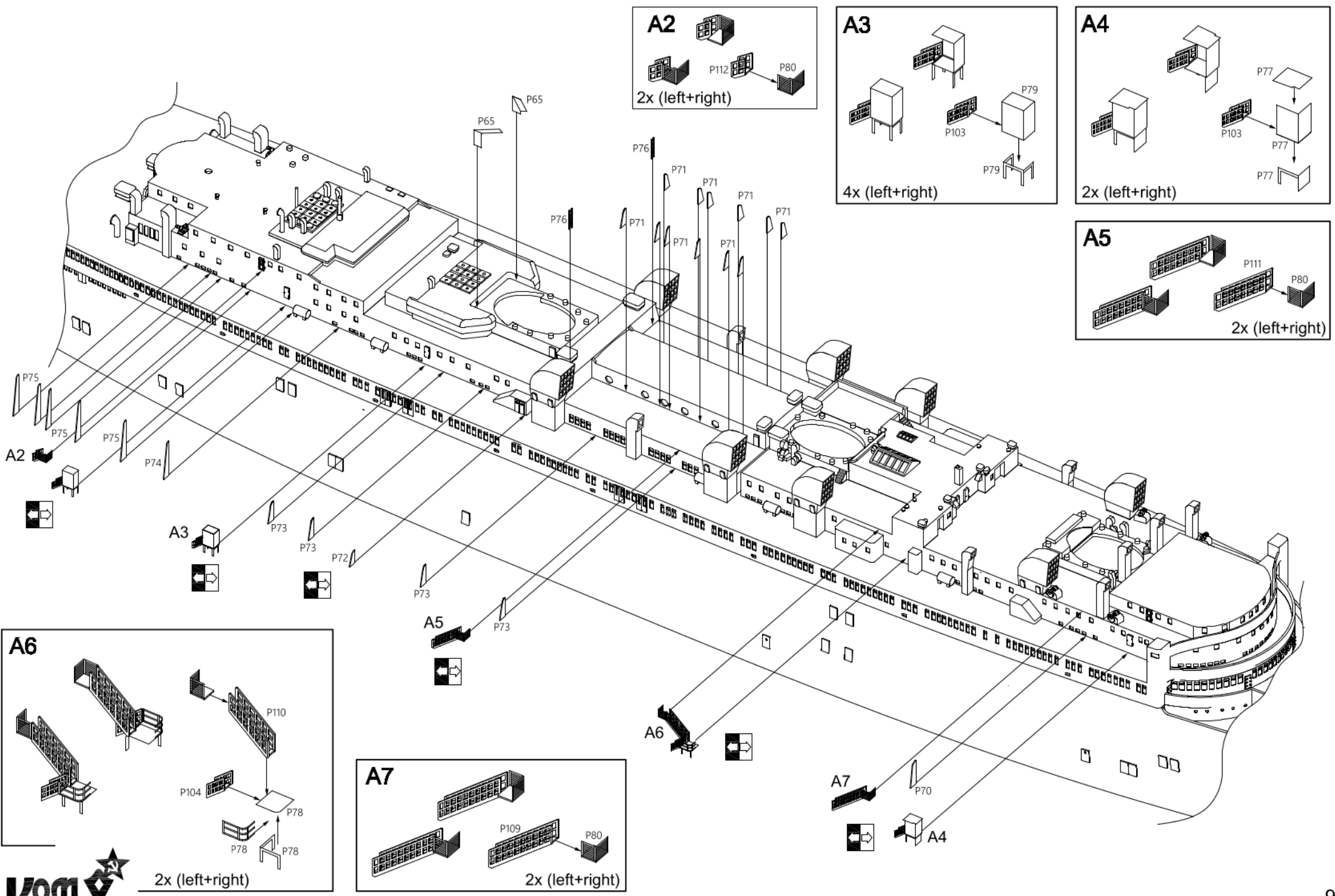

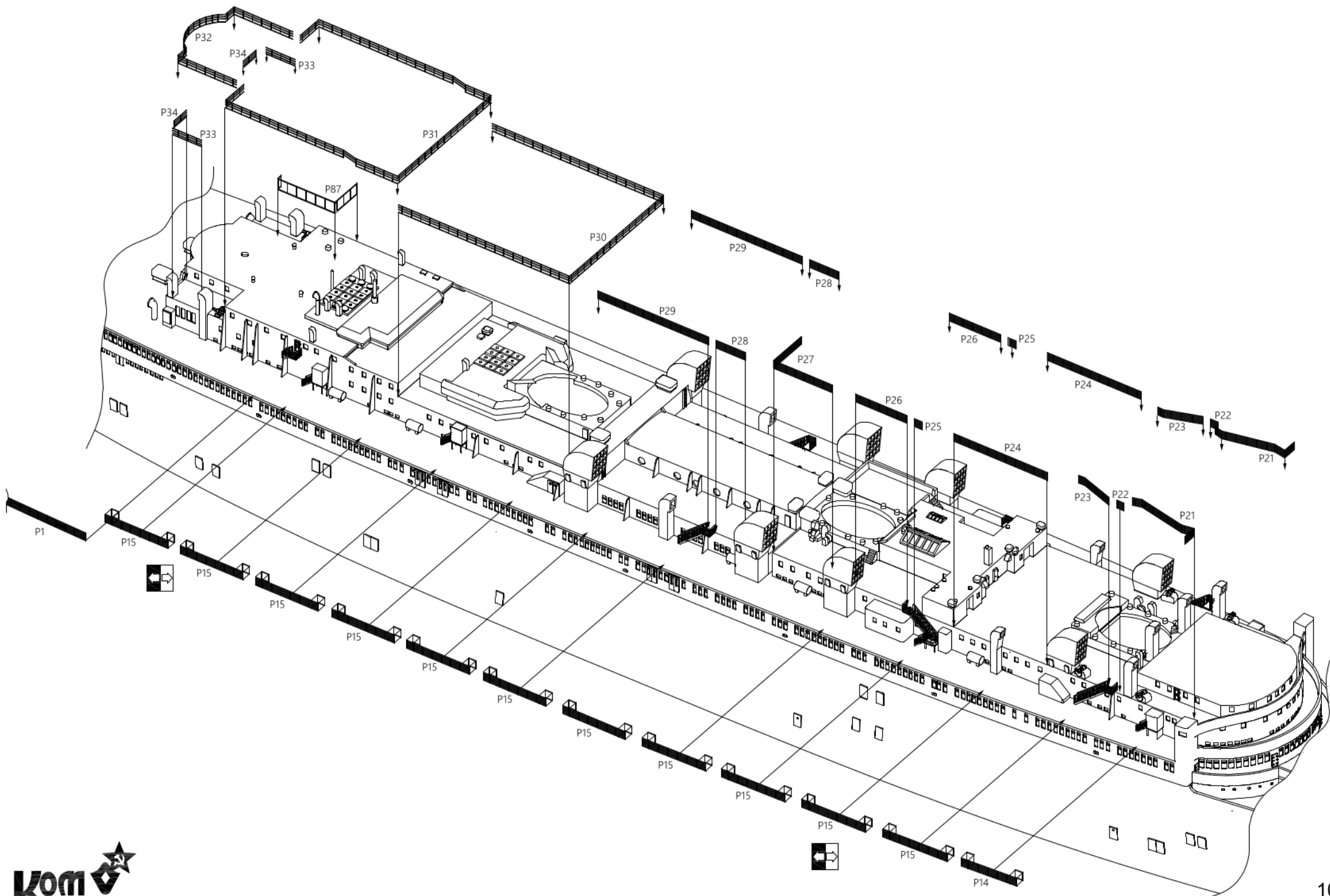

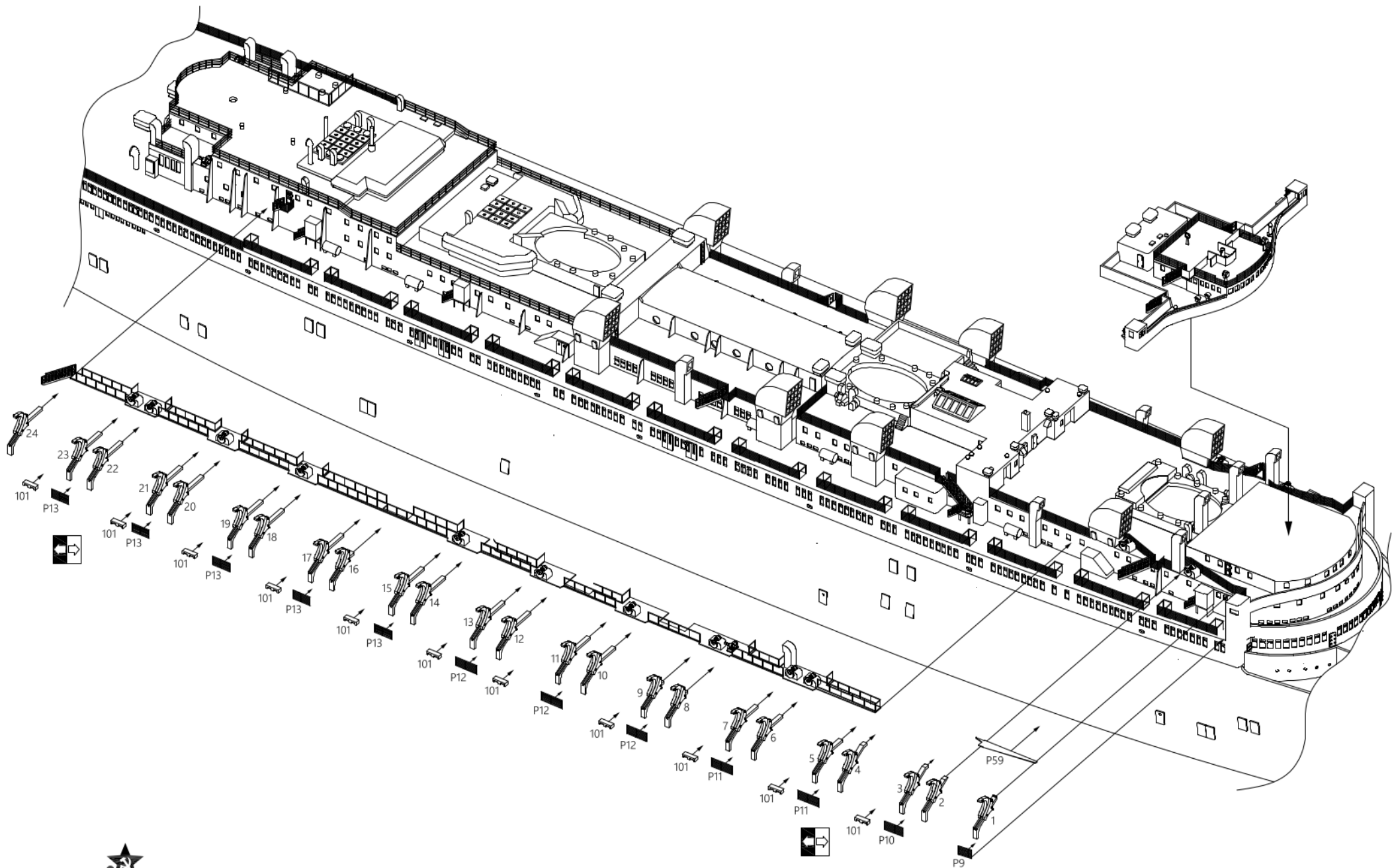

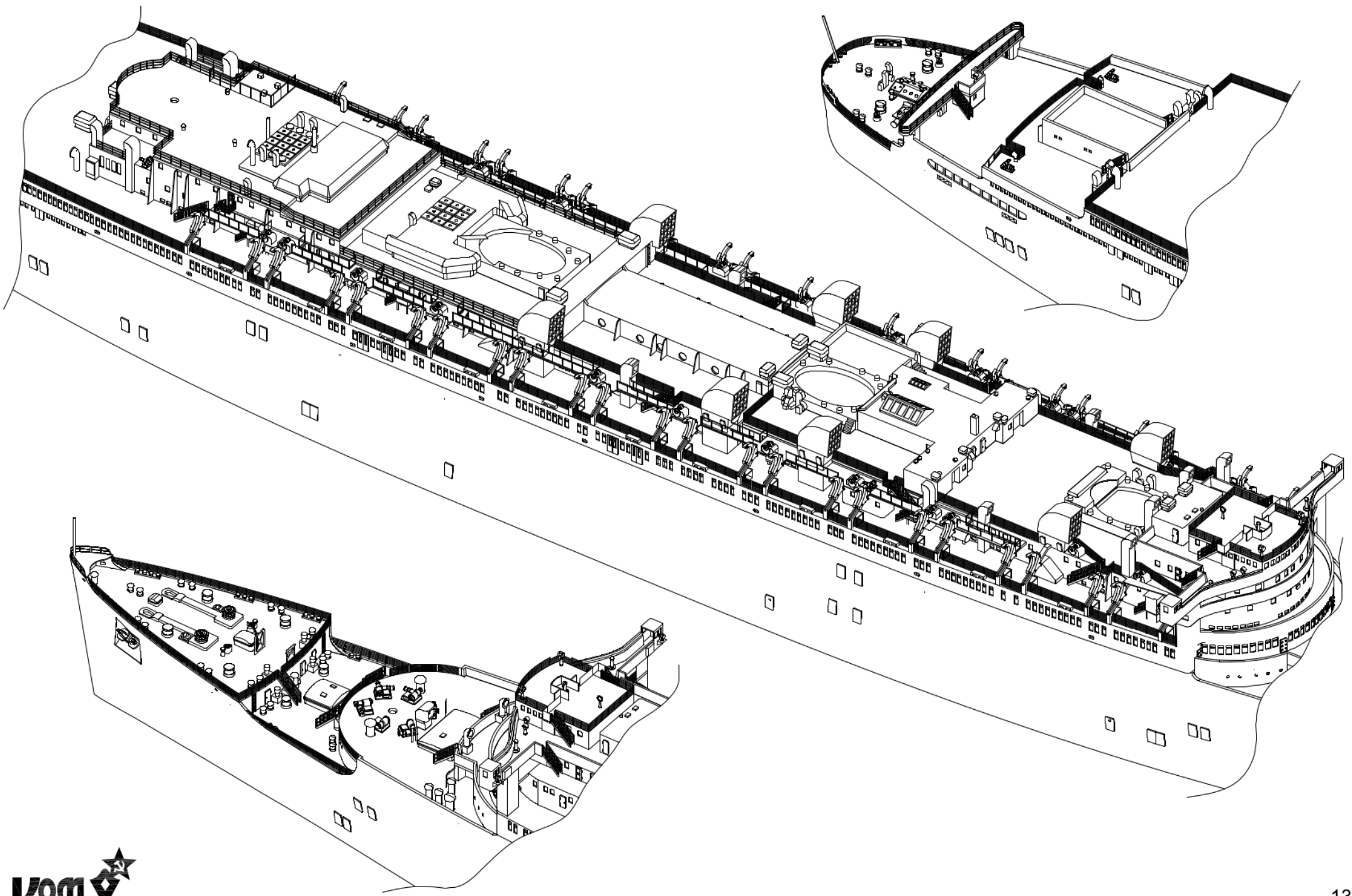

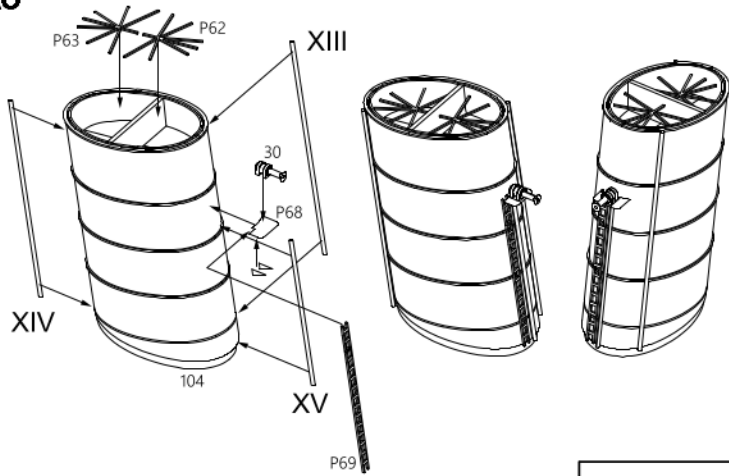
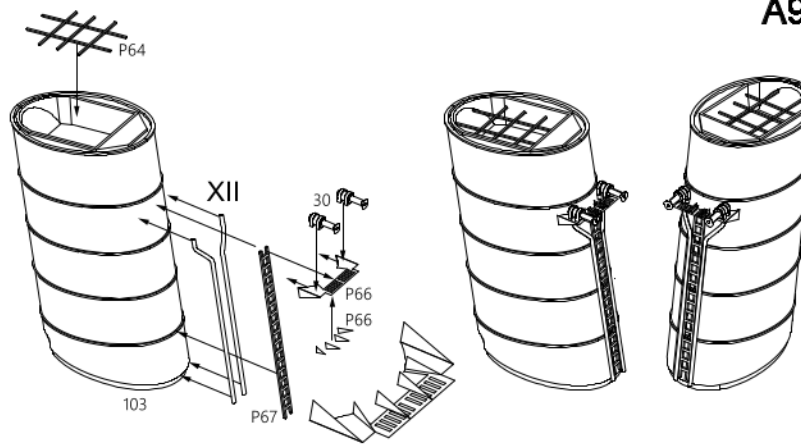
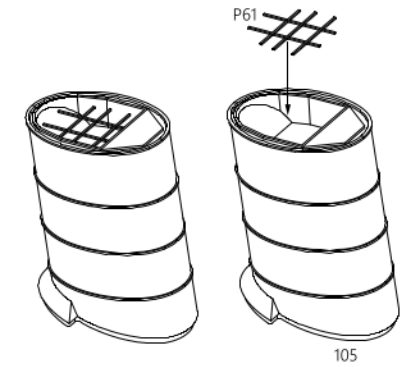
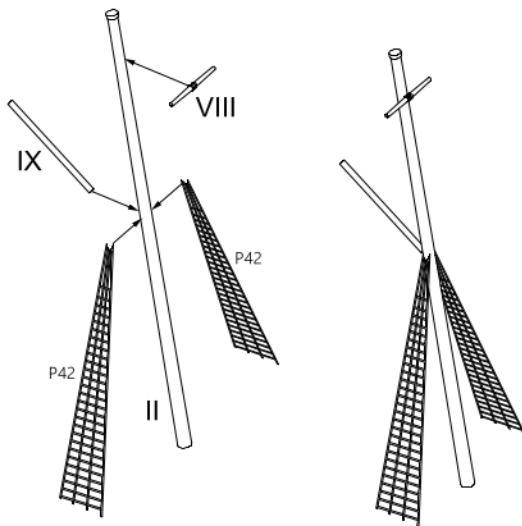
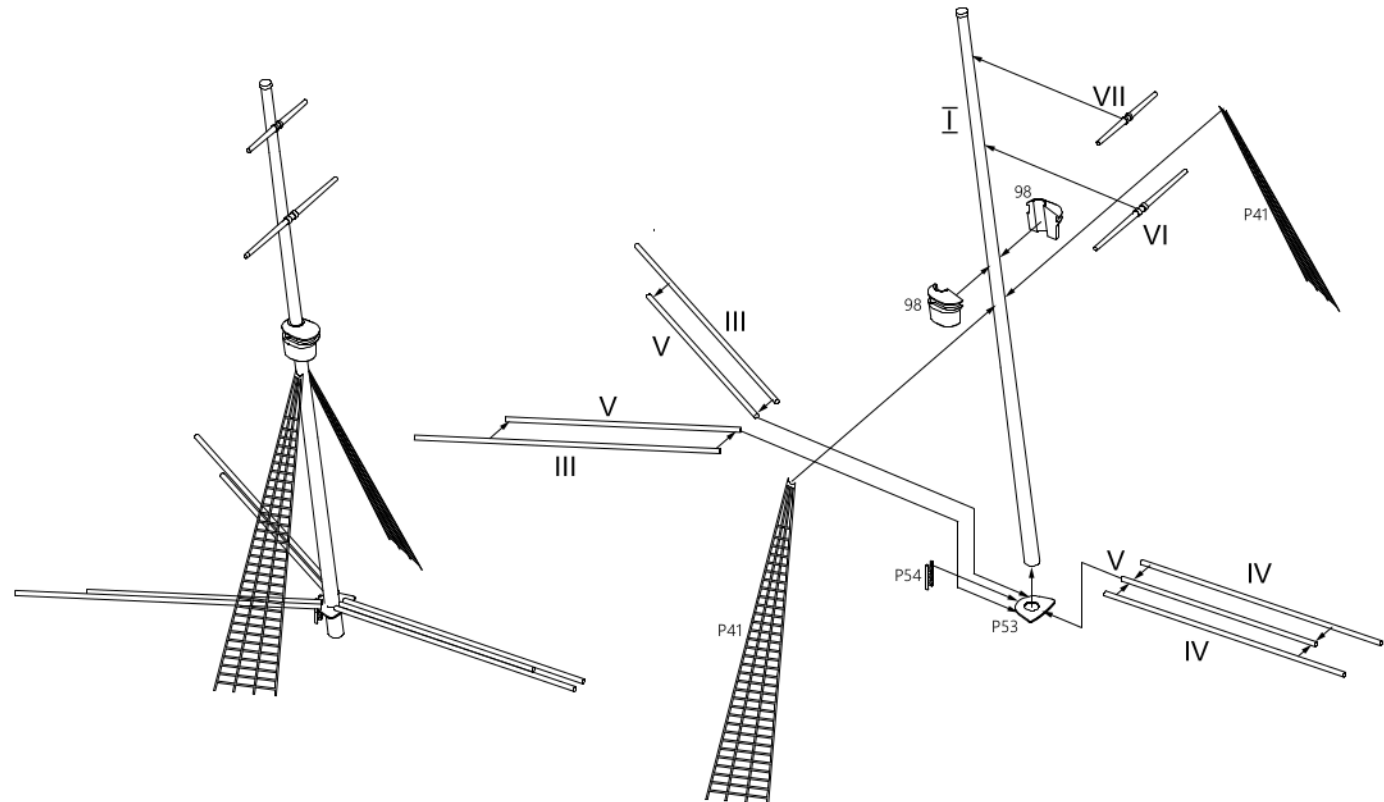
A8**A9****A10****A11****A12**

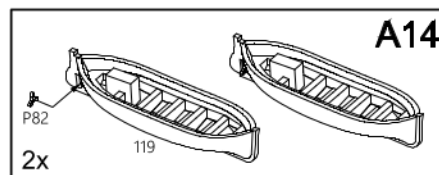
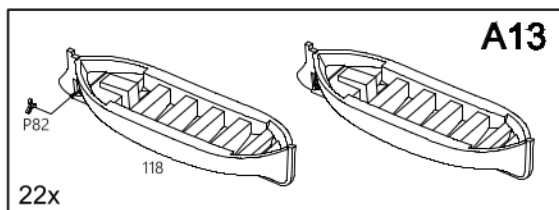
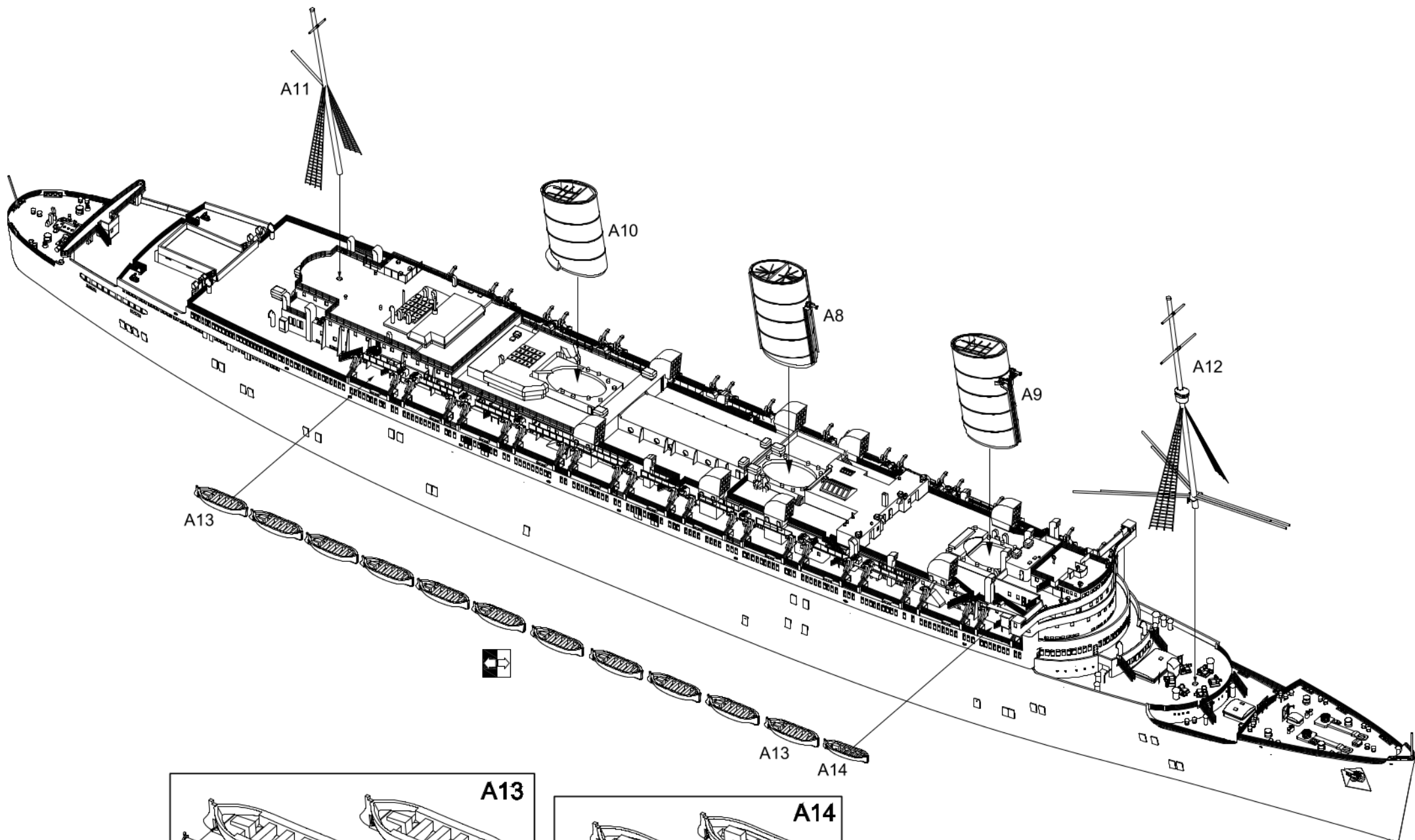

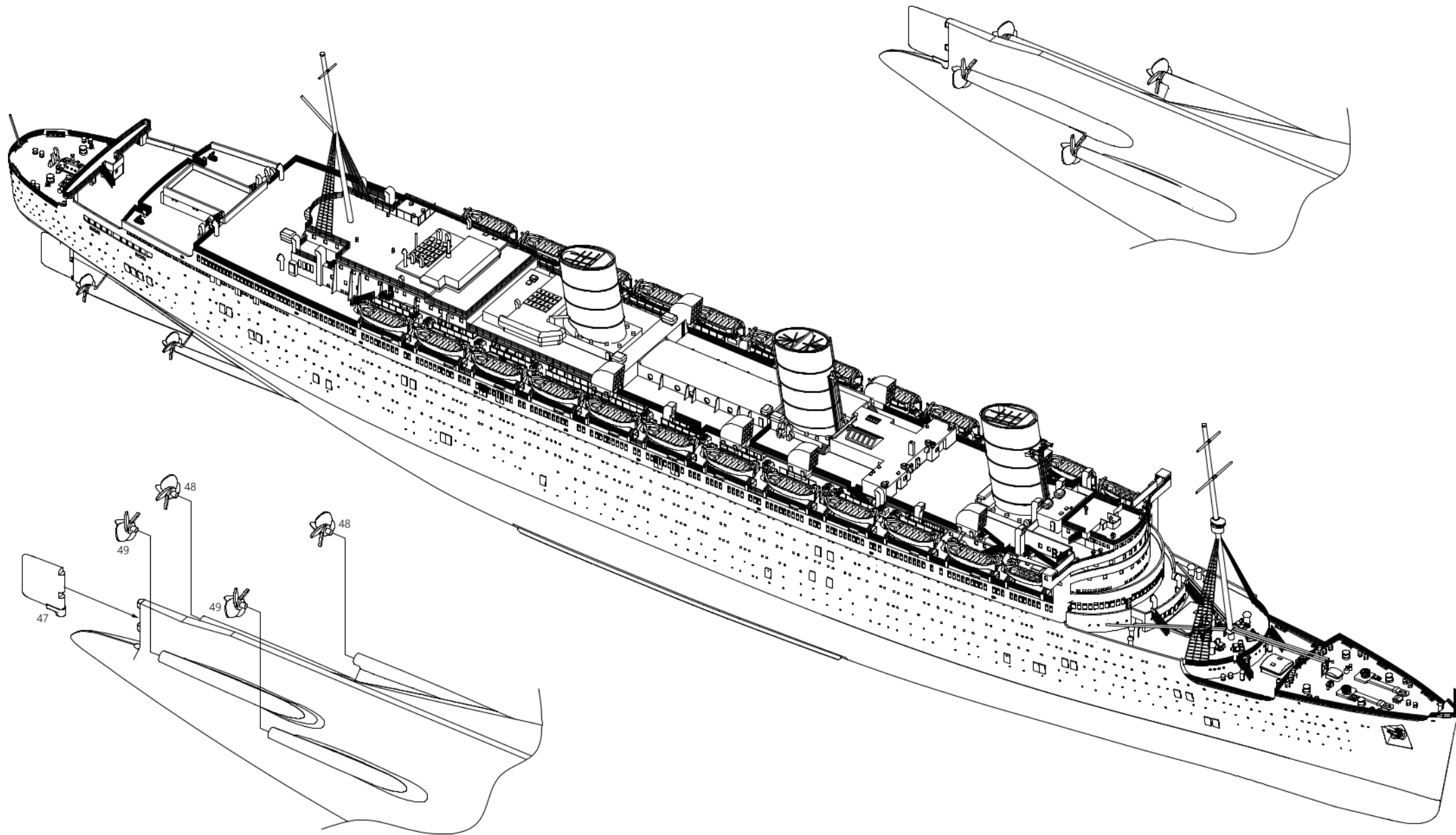



RMS QUEEN MARY

Ocean Liner, 1936

КУИН МЭРИ, Океанский
Лайнер, 1936



Ком
Бриг
Made in Russia

SCALE 1:700

70698FH